

The image features several black surgical plates of various shapes and sizes, arranged diagonally across the frame. Each plate is equipped with multiple locking holes, some of which are filled with colored caps: green, blue, and pink. The plates are shown from different perspectives, highlighting their ergonomic design and the placement of the locking mechanism. A blue gradient banner is positioned in the upper left, containing the title text. A smaller, lighter blue banner is located below the main title, containing the subtitle text.

# DVR<sup>®</sup> Portfolio of Plates

Surgical Technique

The treatment of distal radius fractures experienced a revolution when the DVR Anatomic Volar Plating System was released. Leading the way to a new approach, the DVR plate has helped restore motion to patients worldwide – in the everyday activities that are driven by the hand and wrist. With years of clinical heritage in treating distal radius fractures using the volar approach, the DVR brand continues to evolve.<sup>1-2</sup> The DVR Crosslock System offers an advanced anatomic design, enhanced fixation options over the existing DVR System, and streamlined instrumentation. The improved system has been optimized for fit, efficiency, accuracy and stability. With these improvements, the next generation of DVR plates will continue to refine fracture fixation.

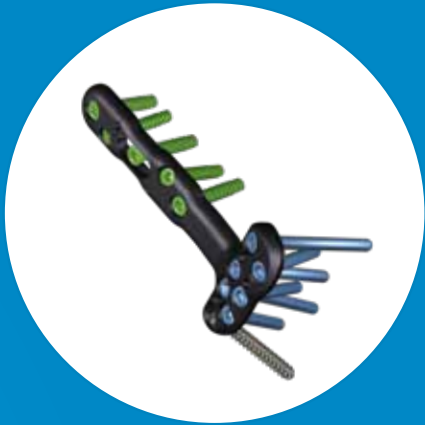

The DVR Crosslock Plate eases the challenge of treating distal radius fractures by incorporating a low-profile, anatomic design that respects the watershed line.

The plate is positioned on bone by k-wire targeting to reference peg distribution without penetrating into the joint. The intersecting proximal and distal pegs form a patented three-dimensional scaffold that provides support of the articulating surface. The cross-locking oblique screws in the shaft provide additional three-dimensional fixation in comminuted and osteoporotic bone. The F.A.S.T. Guide® inserts installed on each plate allow for easy drilling of fixed angle locking screws and visually distinguishes the difference between left and right plates.



The DVR Volar Rim Plate is designed to address volar rim or marginal volar fractures near or distal to the watershed line.

The F.A.S.T. Tabs® Technology is designed to buttress distal fragments while maintaining a low profile. F.A.S.T. Tabs Technology can be modified in-situ, if necessary, for true plate-to-bone conformity. Suture can be used through holes in the F.A.S.T. Tabs Technology for soft tissue approximation, which may help contain very distal fragments.



The DVR Wrist Plate eases the challenge of treating wrist fractures by incorporating a low-profile, anatomic design with advanced fixation options and streamlined instrumentation. The system includes dorsal, radial styloid, and distal ulna plates. The plates are contoured distally to match most anatomies. For bone variations, the plates can be further contoured intra-operatively at the bridge region.

# Table of Contents

<b>DVR Crosslock Distal Radius Plate</b> .....	6
Plate Sizing.....	6
Incision .....	6
Release the FCR Tendon Sheath.....	6
Crossing the Deep Fascia.....	7
Mid-Level Dissection .....	7
Identifying the Watershed Line.....	8
Elevating the Pronator Quadratus.....	8
Release of the Distal Fragment .....	9
Extended FCR Approach .....	9
Intra-Focal Exposure .....	9
Provisional Fracture Reduction .....	10
Proximal Plate Positioning .....	10
Distal Plate Fixation .....	12
Installation of a Multi-Directional (MD) Screw .....	15
Distal Row Plate Fixation.....	15
Final Proximal Plate Fixation .....	16
Final Appearance.....	17
Distal Fragment First Technique For Established Malunions.....	19
Interfragmentary Technique.....	22
Installing Extra Long and Extra Extra Long Plates.....	23
Drilling for Non-Threaded Positions using 3.5mm Screws .....	23
Contouring Extra Extra Long Plates .....	24
Concave/Convex Contouring .....	25
Planar Contouring .....	25
<b>DVR Volar Rim Plate</b> .....	28
Plate Sizing.....	28
Plate Positioning.....	29
Plate Fixation.....	29
Drilling for Non-Threaded Positions .....	30
Measuring for Non-Threaded Positions.....	31
Distal Plate Fixation .....	31
Drilling the Proximal Row.....	32
Measuring Through the F.A.S.T. Guide Insert .....	33
Removing the F.A.S.T. Guide Inserts .....	33
Inserting Locking Screws in Proximal Row .....	34
Inserting a Multi-Directional Screw (MDS) .....	34
Final Plate Fixation.....	35
Inserting the Distal Row Screws.....	35
Bending F.A.S.T. Tabs Technology.....	36

<b>DVR Volar Rim Plate (cont.)</b>	
Tissue Approximation with Sutures.....	37
Final Radiographs.....	38
Final Appearance.....	38
Post-Operation Consideration .....	39
<b>DVR Wrist Plates .....</b>	<b>42</b>
Approach - Incision.....	42
Provisional Fixation.....	43
Screw Selection .....	44
Recommended Screw Order .....	45
Plate Contouring .....	47
Final Appearance.....	48
<b>Ordering Information .....</b>	<b>49</b>
<b>Indications/Contraindications .....</b>	<b>54</b>

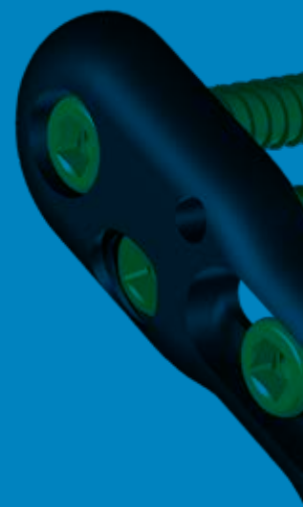

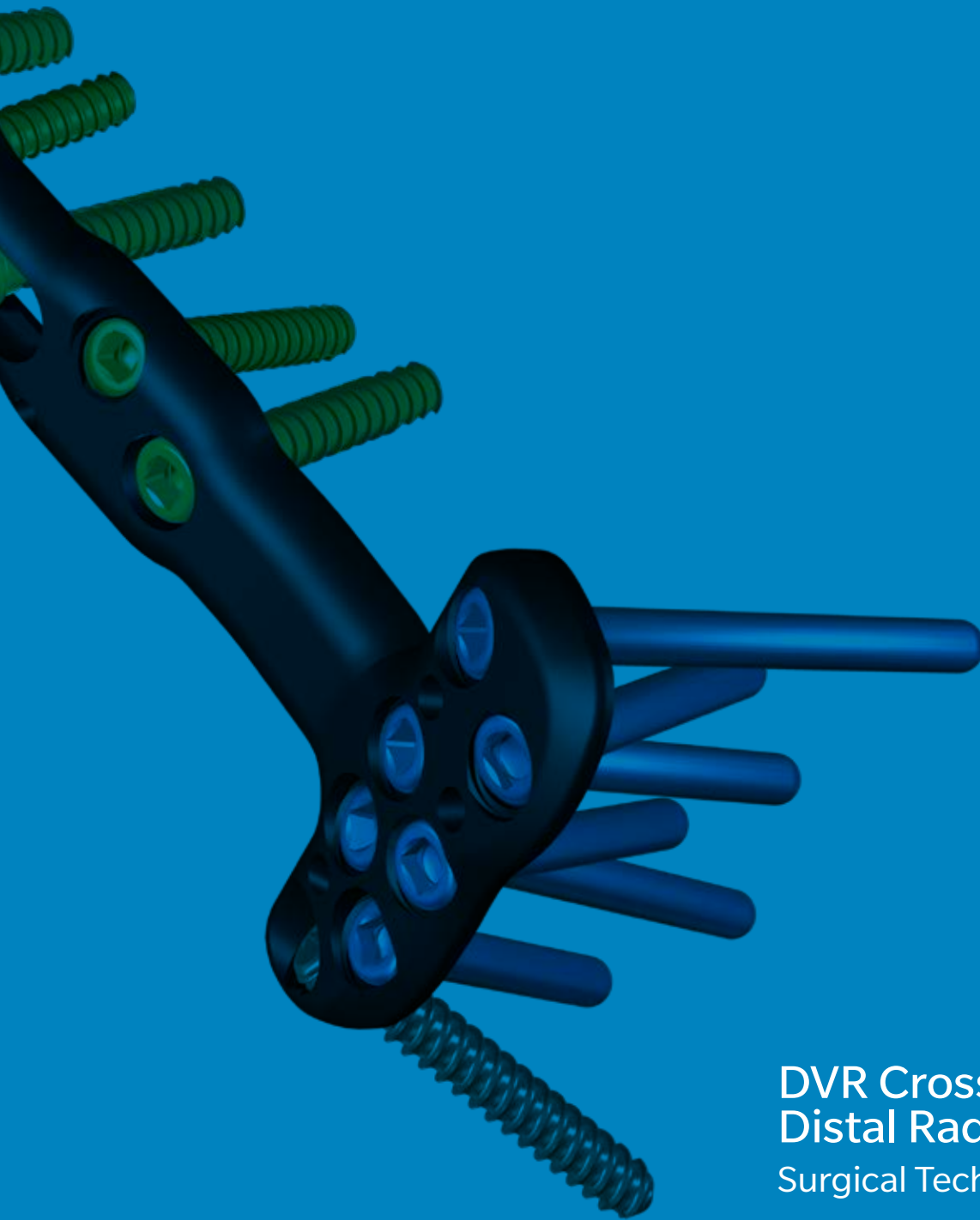

DVR Crosslock  
Distal Radius Plate  
Surgical Technique

## DVR Crosslock Distal Radius Plate

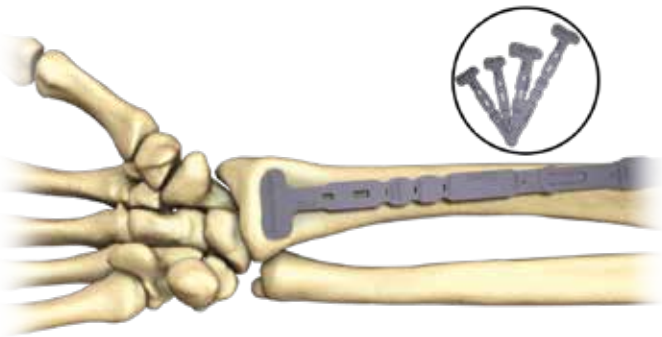

Figure 1

### Plate Sizing

Use the plate sizing template set to determine the head width and plate length that will most closely match the patient's anatomy. Flip the template over to change from right-side to left-side orientation (Figure 1).

**Note:** In situations where the comminution of the fracture makes it difficult to assess the appropriate size, use the opposite hand to establish the appropriate size to use.

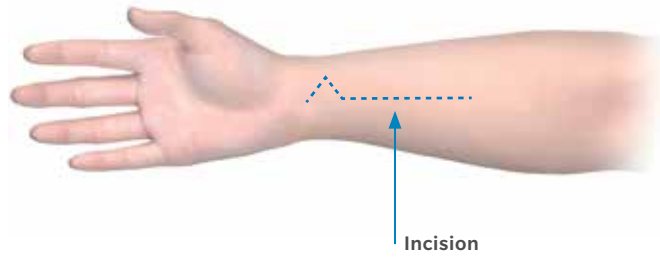

Figure 2

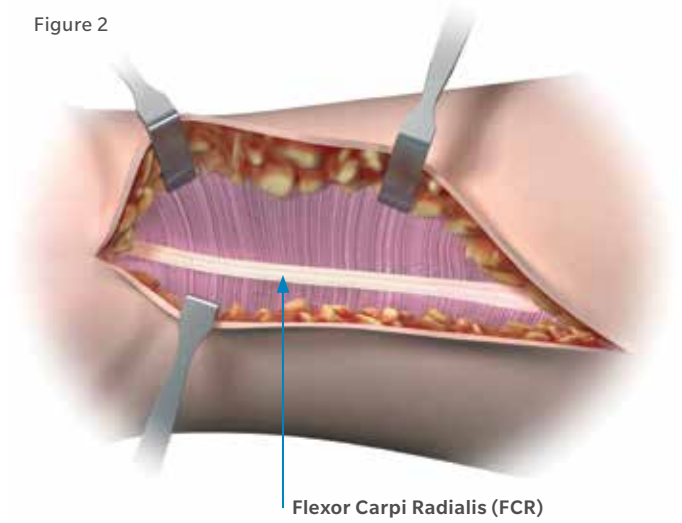

Figure 3

### Incision

Make an incision over the course of the FCR tendon. A zigzag incision is made across the wrist flexion crease to allow better access and visualization (Figure 2).

### Release the FCR Tendon Sheath

Expose and open the sheath of the FCR tendon (Figure 3). Dissect the FCR tendon distally to the level of the superficial radial artery.



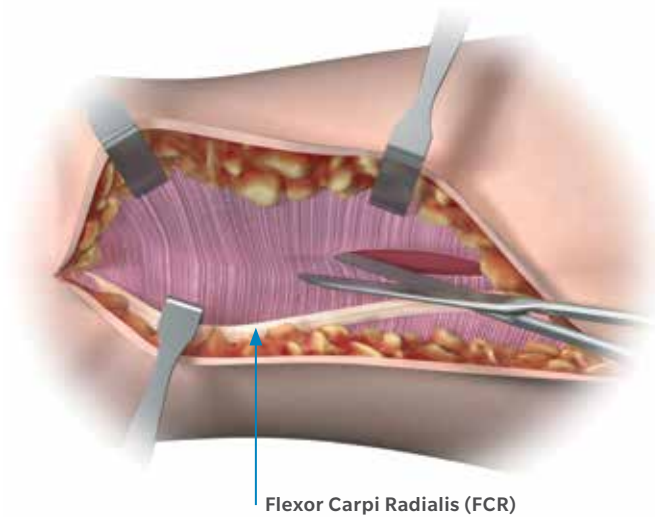

Figure 4

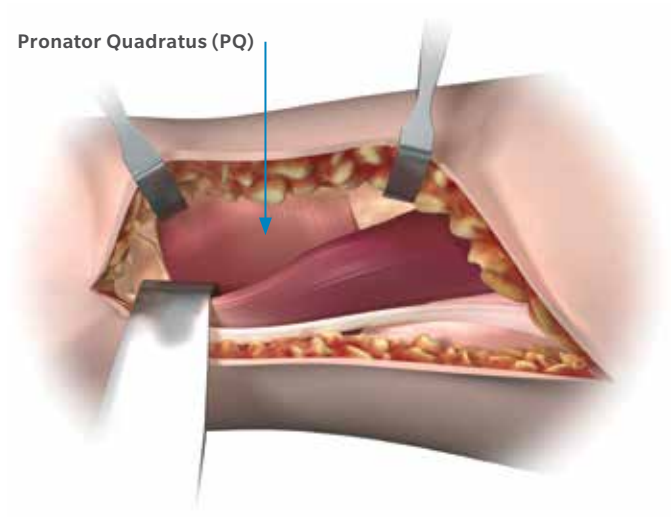

Figure 5

### Crossing the Deep Fascia

Retract the FCR tendon toward the ulna while protecting the median nerve (Figure 4). Incise through the floor of the FCR sheath to gain access to the deeper levels.

Split the sheath of the FCR tendon distally up to the tuberosity of the scaphoid.

### Mid-Level Dissection

Develop the plane between the flexor pollicis longus (FPL) and the radial septum to reach the surface of the radius (Figure 5).

Develop widely the subtendinous space of parona and expose the pronator quadratus muscle (PQ).

## DVR Crosslock Distal Radius Plate

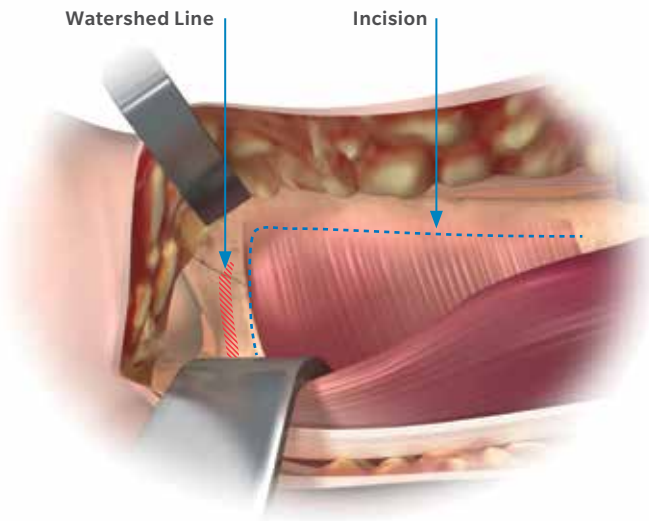

Figure 6

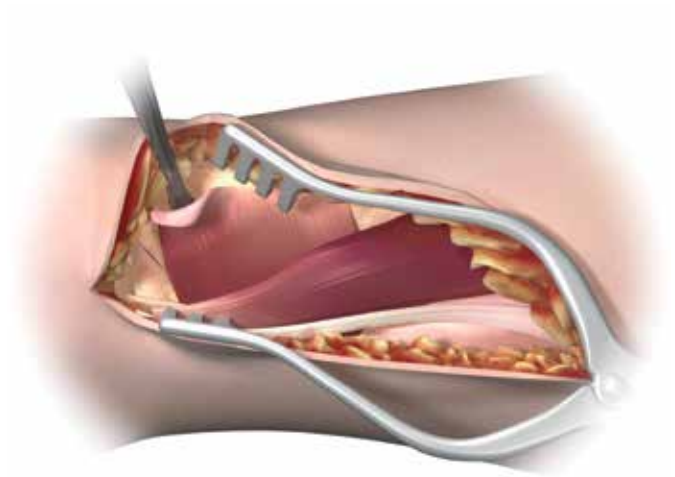

Figure 7

### Identifying the Watershed Line

Palpate the radius distally to identify the volar rim of the lunate fossa. This establishes the location of the watershed line (Figure 6). The transitional fibrous zone (TFZ) is a band of fibrous tissue located between the watershed line and the PQ that must be elevated to properly visualize the fracture. Release the PQ by sharply incising over the watershed line and proximally on the lateral edge of the radius (Figure 6).

### Elevating the Pronator Quadratus

Use a periosteal elevator to elevate the PQ to expose the volar surface of the radius (Figure 7). The fracture line on the volar cortex is usually simple, which facilitates reduction. The origin of the FPL muscle can be partially released for added exposure.

ⓘ **Caution:** Use caution not to rupture the pronator quadratus.

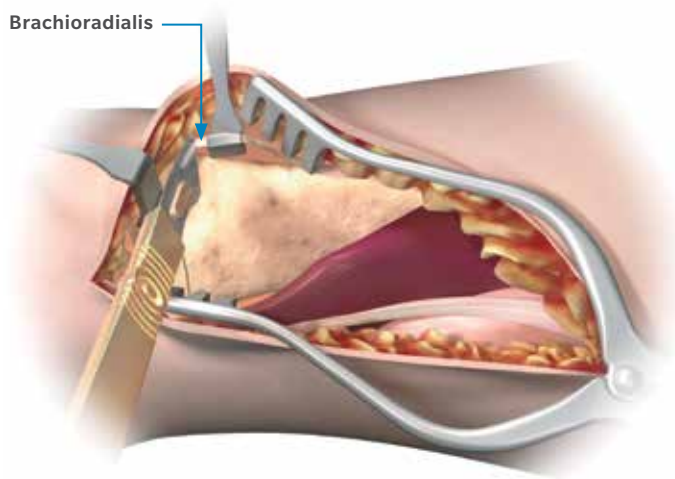

Figure 8

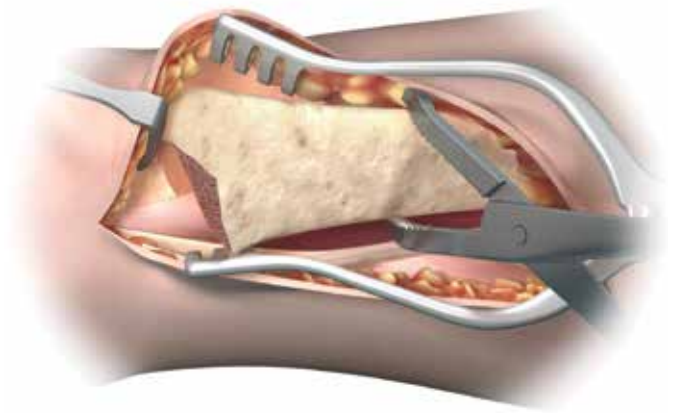

Figure 9

## Release of the Distal Fragment

Release the insertion of the brachioradialis which is found on the floor of the first compartment in a step cut fashion (Figure 8).

⊖ **Note:** The brachioradialis is the prime deforming force of the distal fragment.

Identify and retract the abductor pollicis longus (APL) and extensor pollicis brevis (EPB) tendons.

⊖ **Important:** Care should be taken to protect the radial artery.

## Extended FCR Approach

Pronation of the proximal fragment out of the way provides exposure to the dorsal aspect of the fracture, allowing fracture debridement and reduction.

## Intra-Focal Exposure

Intra-focal exposure is obtained by pronating the proximal fragment out of the way. A bone clamp facilitates this maneuver (Figure 9). Preserve the soft tissue attachments to the medial aspect of the proximal fragment.

⊖ **Note:** This is where the anterior interosseous vessels that feed the radial shaft are located.

## DVR Crosslock Distal Radius Plate

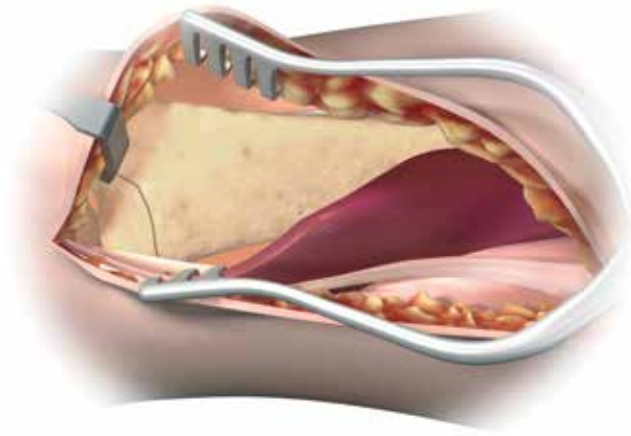

Figure 10

### Provisional Fracture Reduction

After fracture debridement, supinate the proximal radius back into place and restore radial length by reducing the volar cortex (Figure 10).

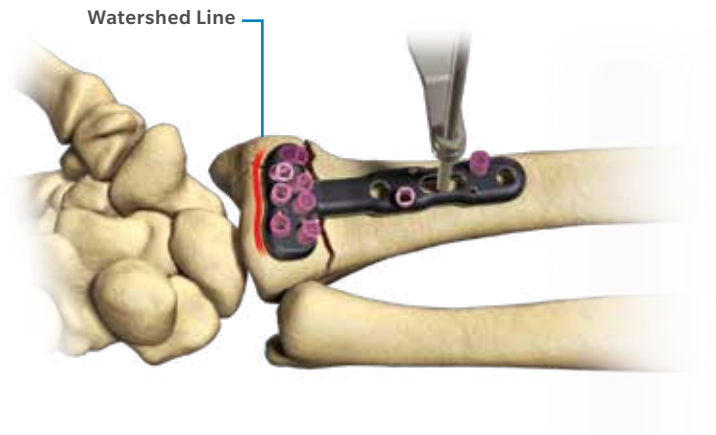

Figure 11

### Proximal Plate Positioning

Determine the correct position for the plate by judging how the plate conforms to the watershed line and the volar surface of the radius.

Using the 2.2 mm drill bit with the soft tissue guide, drill through the center of the proximal oblong hole of the plate, which will allow for plate adjustments (Figure 11).

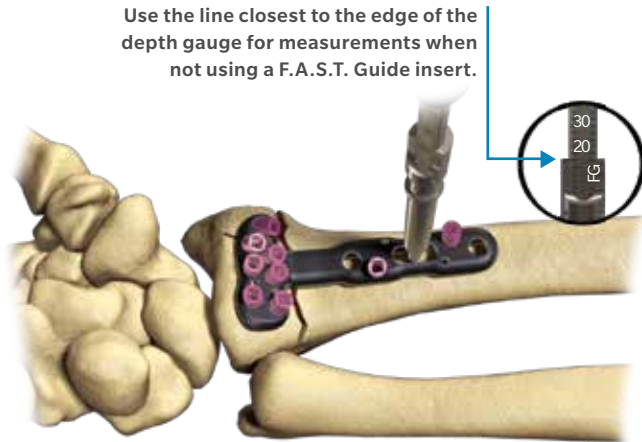

Figure 12

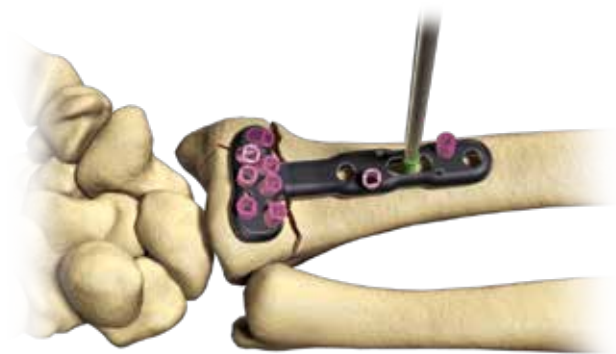

Figure 13

Measure the required screw length using the line closest to the edge of the depth gauge.

When selecting a screw for the oblong hole or any other non-threaded screw hole, round up measurement to the nearest 1 or 2 mm (Figure 12).

ⓘ **Note:** The depth gauge has a FG mark to facilitate the use of the gauge with a F.A.S.T. Guide insert. The opposing side should be used when measuring without a F.A.S.T. Guide insert.

Insert the appropriate length 2.7 mm locking screw using the square driver (Figure 13).

ⓘ **Note:** Locking screws are designed to work in the locking, non-locking, and oblong holes.

## DVR Crosslock Distal Radius Plate



Figure 14

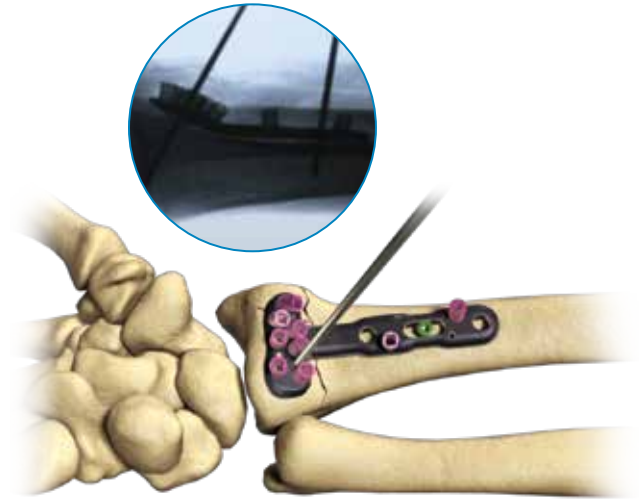

Figure 15

### Distal Plate Fixation

#### Final Fracture Reduction

Final reduction is obtained by indirect means using the DVR Crosslock plate as a template, then applying traction, ligamentotaxis, and direct pressure over the dorsal aspect (Figure 14).

ⓘ **Note:** A properly applied bolster helps to maintain the reduction.

First, secure the distal fragment to the plate by inserting a K-wire through the most ulnar K-wire hole in the proximal row (Figure 15).

Proper plate positioning can be confirmed using fluoroscopy by obtaining a 20–30 degree lateral image.

The K-wire should be 2–3 mm subchondral to the joint line on this view.

ⓘ **Note:** K-wires installed in the proximal row aid in reduction of the distal fragments and allow proper assessment of peg or screw placement prior to drilling.



Figure 16

### Drilling the Proximal Row

Using the 2.2 mm drill bit, drill through the proximal single-use F.A.S.T. Guide inserts starting on the ulnar side in order to stabilize the lunate fossa (Figure 16).

⊖ **Note:** Bend the K-wire out of the way to facilitate drilling.

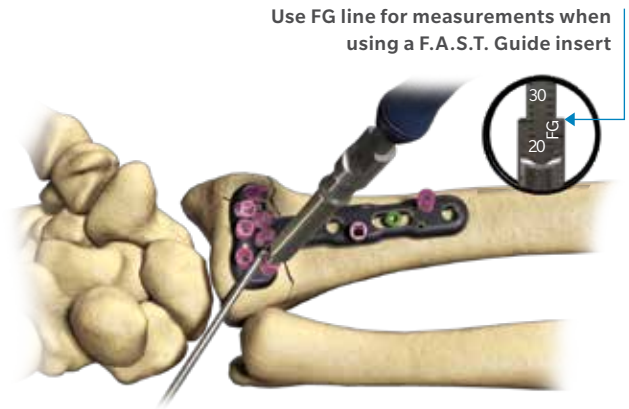

Figure 17

### Measuring Through the F.A.S.T. Guide Insert

Measure the drilled hole with the depth gauge by taking a direct reading from the FG line (Figure 17).

The depth gauge reading will provide a direct measurement. When selecting screws in the metaphysis, choosing a screw 1 mm or 2 mm less than the reading may reduce the risk of tissue irritation.

⊖ **Note:** If the F.A.S.T. Guide insert is removed before measuring the screw length, use the line closest to the edge of the depth gauge.



## DVR Crosslock Distal Radius Plate

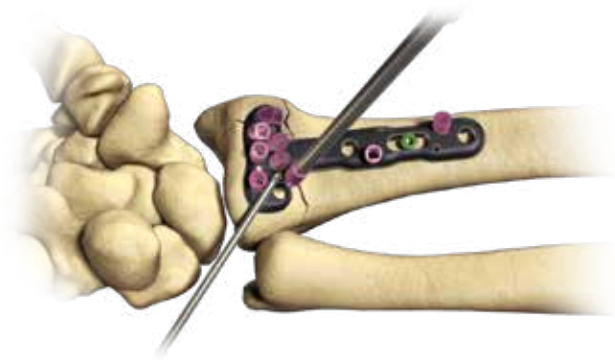

Figure 18

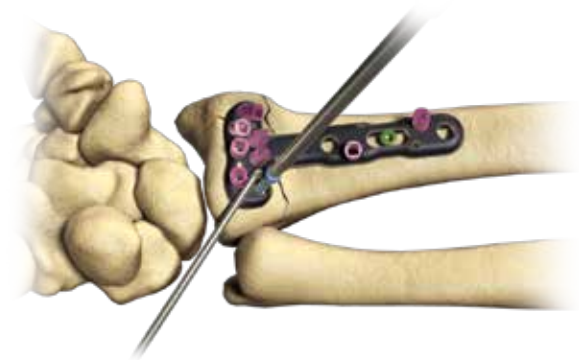

Figure 19

### Distal Plate Fixation (cont.)

#### Proximal Row of the Head of the Plate

Remove each F.A.S.T. Guide insert with the square driver after checking the drilled depth (Figure 18).

Using the same driver, fill the holes in the head of the plate with the appropriate length locking screws or pegs. The illustration shows a peg being installed (Figure 19).

- ⓘ **Note:** 2.7 mm non-locking screws are provided for temporary lagging of bone fragments in distal portion of plate. Replacing non-locking screws with locking screws or pegs in the plate will provide rigid fixation. 2.7 mm non-locking screws can also be used as stand alone lag screws for loose fragments.
- ⓘ **Note:** Using a power screwdriver is not recommended for insertion of any screw. Perform all final screw tightening by hand.



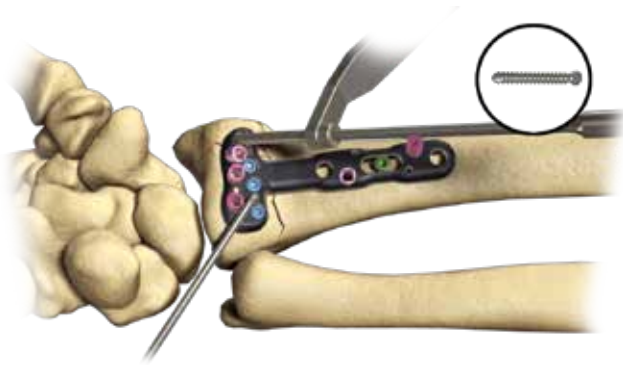

Figure 20

## Installation of a Multi-Directional (MD) Screw

A MD screw option is provided for locked fixation within a 20 degree cone of angulation off the fixed angle trajectory.

Remove the F.A.S.T. Guide inserts using the square driver.

Place the 2.2 mm end of the soft tissue guide into the radial styloid and/or the most ulnar hole in the proximal row of the DVR Crosslock plate.

ⓘ **Note:** Fluoroscopy should be used to avoid placing a MD screw in the intra-articular joint space.

Place the 2.2 mm drill bit through the soft tissue guide until it comes in contact with the bone. Determine the trajectory of the drill bit by varying the angle of the soft tissue guide and drill (Figure 20).

ⓘ **Note:** MD screw can be used in any threaded locking hole.



Figure 21

## Distal Row Plate Fixation

### Final Plate Fixation

Fill all the holes of the distal row (Figure 21).

As the distal row of the head of the plate converges on the proximal row between 14 mm and 16 mm, typically a 16 mm length peg/screw is all that is needed in the distal row.

ⓘ **Note:** The proximal row provides support to the dorsal aspect of the articular surface. The distal row provides support to the central and volar aspects of the subchondral plate.

Remove all F.A.S.T. Guide inserts even if the screw hole is not used.

## DVR Crosslock Distal Radius Plate



Figure 22



Figure 23

### Final Proximal Plate Fixation

Apply the remaining 2.7 mm locking screws in the non-threaded screw holes. Use the same technique as inserting a screw through the oblong hole (see page 10).

Angled screw holes with F.A.S.T. Guide inserts are locking screw hole options. To apply locking screws in the shaft, use the same technique as applying locking screws in the distal end of the plate (Figures 22 and 23).

The 2.2 mm locking drill guide is available for use in any threaded hole. Install the threaded drill guide until fully seated. Drill both cortices with the 2.2 mm drill bit. Read the required length from the line closest to the edge of the depth gauge and install appropriate length 2.7 mm locking screws

ⓘ **Note:** Long plates will not have preinstalled F.A.S.T. Guide inserts in every threaded shaft hole.

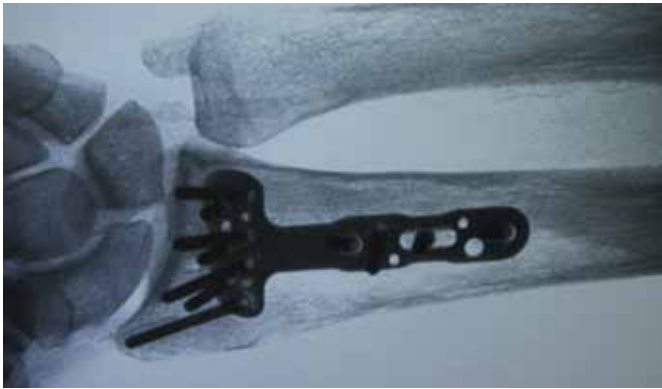

Figure 24



Figure 25

## Final Proximal Plate Fixation (cont.)

### Final Radiographs

A 20–30 degree elevated lateral fluoroscopic view allows visualization of the articular surface, evaluation of the volar tilt, and confirmation of proper peg/screw placement 2–3 mm proximal to the subchondral surface (Figure 24).

To confirm that the length of each individual peg/screw is correct, pronate and supinate the wrist under fluoroscopy.

### Final Appearance

A properly applied plate should be just proximal to the watershed line and not project above or beyond it in order to avoid contact with the flexor tendons (Figure 25).

⚠ **Caution:** Ensure all F.A.S.T. Guide inserts are removed prior to closing.

## DVR Crosslock Distal Radius Plate

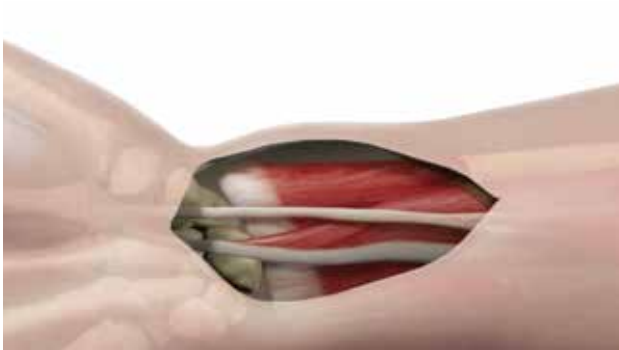

Figure 26

### Final Appearance (cont.)

#### Wound Closure

Repair the transitional fibrous zone (TFZ) in order to cover the distal edge of the DVR Crosslock Plate (Figure 26).

Repair the brachioradialis.

Suture the pronator quadratus muscle (PQ) to the transitional fibrous zone (TFZ) and the repaired brachioradialis.



Figure 27

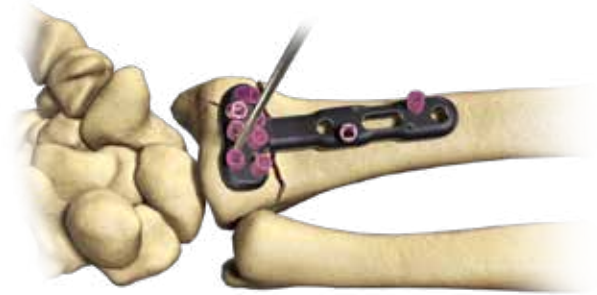

Figure 28

### Distal Fragment First Technique For Established Malunions

Complete exposure and place a K-wire 2-3 mm proximal to the articulating surface and parallel to the joint line (Figure 27).

ⓘ **Note:** Use the K-wire hole on the distal row of the DVR Crosslock Plate as a guide for proper implant placement (Figure 28).

## DVR Crosslock Distal Radius Plate

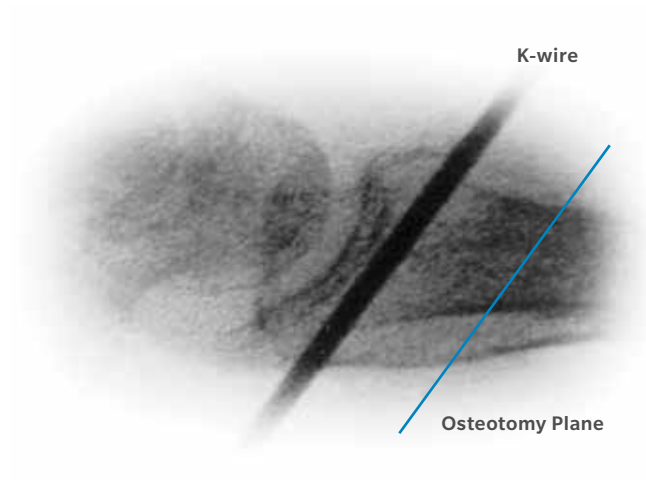

Figure 29

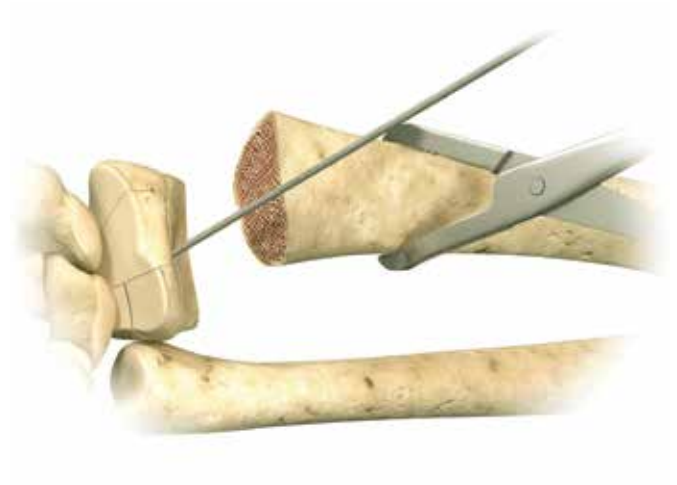

Figure 30

### Distal Fragment First Technique For Established Malunions (cont.)

Create the osteotomy plane parallel to the K-wire (Figure 29).

Release the brachioradialis, then pronate the radius and release the dorsal periosteum (Figure 30).

**Note:** The location of the distal row can be identified and drilled prior to the osteotomy.



Figure 31

Supinate the proximal fragment and slide the DVR Crosslock Plate over the K-wire.

The K-wire will assure proper restoration of the volar tilt (Figure 31).

⊖ **Note:** Plate acts as a template that aids in the proper restoration of the volar tilt.



Figure 32



Figure 33

Fix the DVR Crosslock Plate to the distal fragment (Figures 32 and 33). The watershed line provides guidance for proper radiolunate deviation.

Once distal fixation is complete, the shaft of the implant is secured to the shaft of the radius to re-create the normal volar tilt.

## DVR Crosslock Distal Radius Plate



Figure 34

### Distal Fragment First Technique For Established Malunions (cont.)

If applicable after fixation, autograft is applied and the wound is closed (Figure 34).

Confirm postoperative results with radiographs.

### Interfragmentary Technique

Reduce the fracture and maintain the reduction with bone forceps. Drill a gliding hole in the near cortex with the 2.9 mm drill bit using the 2.2/2.9 mm soft tissue guide.

Insert the 2.2 mm end of the 2.2/2.9 mm soft tissue guide into the glide hole. Drill a pilot hole into the far cortex with the 2.2 mm drill bit.

Determine the required screw length by taking a direct reading using the line closest to the edge of the depth gauge. When selecting a 2.7 mm non-locking screw, round up measurement to the nearest 1 or 2 mm. Insert the appropriate length 2.7 mm non-locking screw with the square driver.



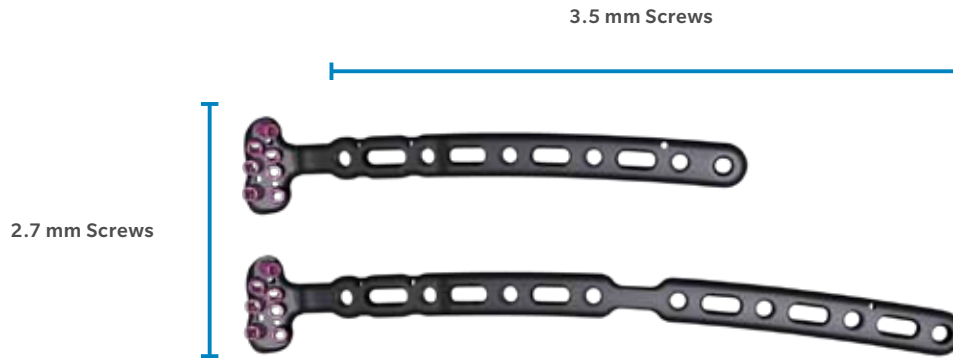

Figure 35

## Installing Extra Long and Extra-Extra Long Plates

The Extra Long and Extra Extra Long DVR Crosslock plates are designed to be used with 2.7 mm screws in the distal section of the plate and 3.5 mm screws in the shaft. (Figure 35) The 2.2 mm Drill Bit is intended to be used with the 2.7 mm Locking Screws, 2.7 mm Non-Locking Screws, and the 2.2 mm Locking Smooth Pegs, and the 2.7 mm Drill Bit is intended to be used with the 3.5 mm Locking Screws. The 2.7 mm Drill Bit will be pre-loaded onto the 2.7 mm Soft Tissue Guide. The screwdriver is specially designed to work with all the screws and pegs described in this section.

ⓘ **Note:** The extra long and extra extra long are only available as a sterile implant.

## Drilling for Non-Threaded Positions using 3.5 mm Screws

For the Extra Long and Extra Extra Long plates, use 3.5 mm locking screws in the shaft. Do not use 2.7 mm screws. Use the 2.7 mm Drill Bit with the 2.7 mm Soft Tissue Guide to drill through the proximal oblong holes of the plate. Measure the required screw length using the non-FG line of the depth gauge. When selecting screws in the oblong holes, round up measurement to the nearest 1 or 2 mm. Insert a 3.5 mm Screw with the screwdriver.

ⓘ **Note:** 3.5 mm Screws are designed to work in the locking and oblong holes in the shaft. The 3.5 mm Screws, drill bit and 2.7 mm Soft Tissue Guide are available single sterile pack. Refer to ordering information section for more information.

## DVR Crosslock Distal Radius Plate



Figure 36

### Drilling for Threaded Positions using 3.5 mm Screws

Insert the 2.7 mm Long Drill Guide through the threaded locking hole (Figure 36). Use 2.7 mm Drill Bit to drill hole. Remove the Long Drill Guide. Measure the depth of the hole using the depth gauge and reading from the non-FG line. Insert appropriate length screw.

**Note:** Additional sterile-packed screws are available if required.

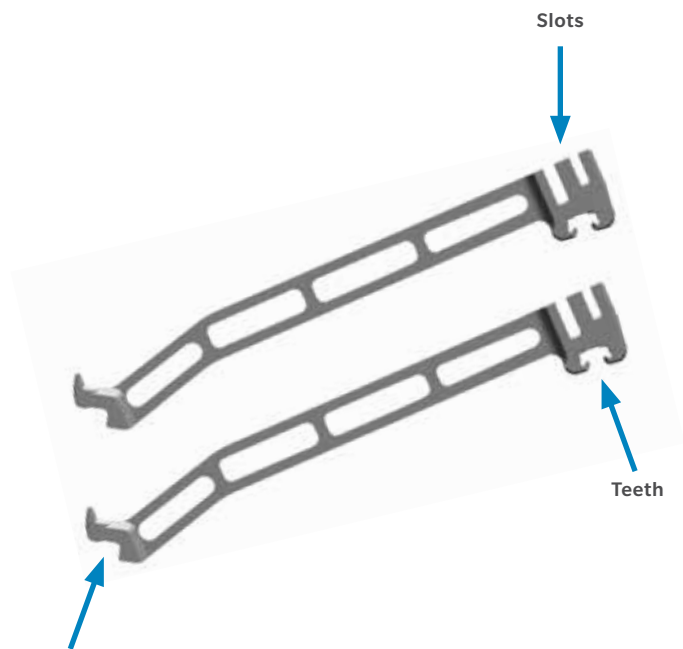

Figure 37

Figure 37

### Contouring Extra-Extra Long Plates

The plates are designed to closely match the anatomy. In cases where there is variation in the curvature of the shaft of the radius, these plates can be further contoured at the bridge region. Plates can be bent in the concave/convex and planar directions by utilizing the plate benders. Benders consist of 3 bending features: the foot, the slot, and the planar bending feature (teeth). The plate benders come non-sterile and are located in the DVR Crosslock non-sterile tray (Figure 37).

**Note:** Only the Extra Long and Extra Extra Long Plates can be contoured.

**Note:** Bending irons are not offered as sterile instruments.

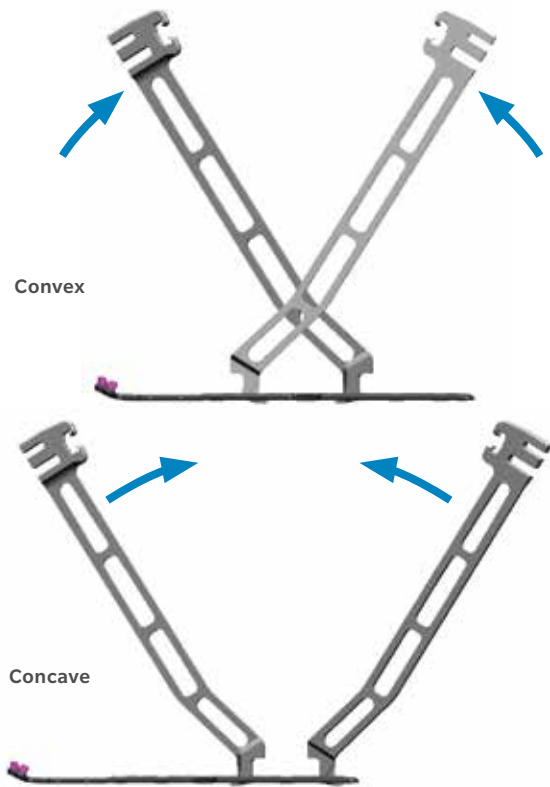

Figure 38

### Concave/Convex Contouring

Using the “feet” of the benders the plates can be contoured to conform to the patient’s unique anatomic needs. The foot of the bender is placed inside the slotted section of the plate and engaged on the underside of the plate. The benders can be used either facing or opposing each other to create concave or convex bends (Figure 38). There must be at least one empty slot in-between benders to ensure there is no thread deformation of locking hole.

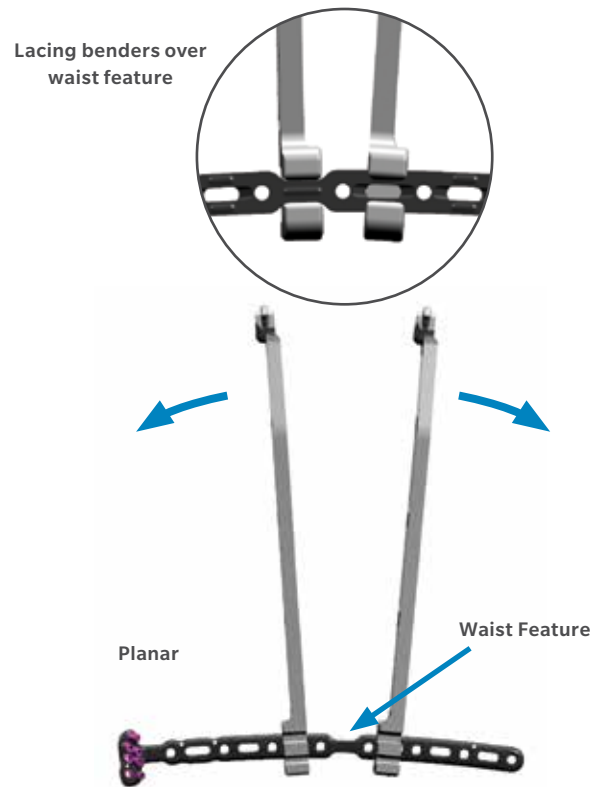
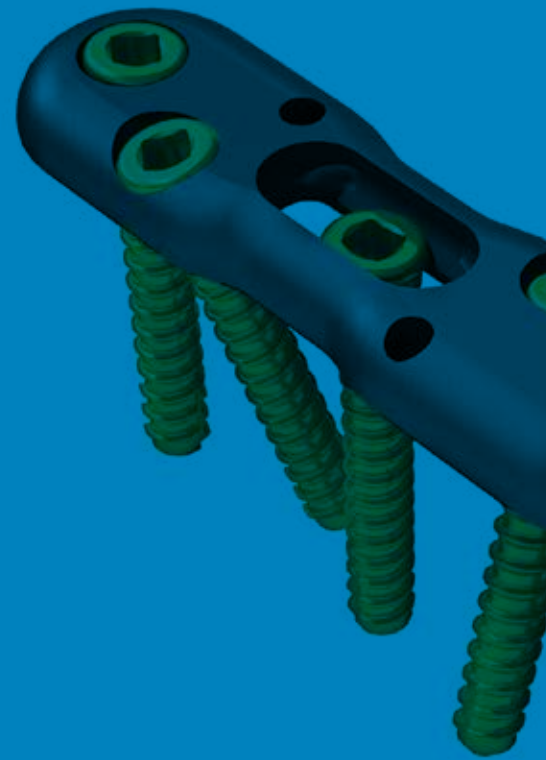
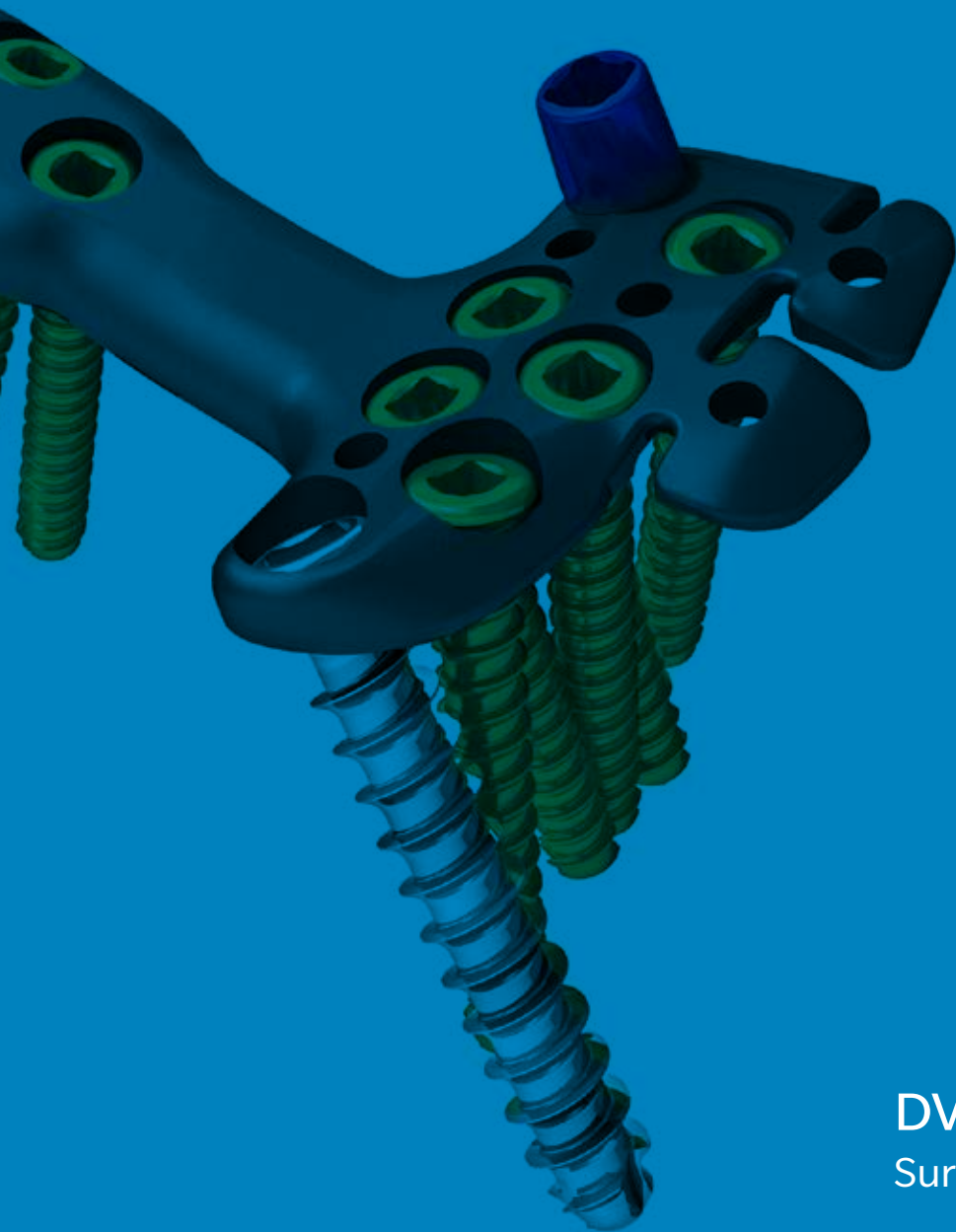

Figure 39

### Planar Contouring

To apply a planar bend, use “teeth” of the benders. Insert “teeth” of benders to slots adjacent to waist feature of DVR Crosslock plates, pull benders away from one another to impart planar bend (Figure 39).





## DVR Volar Rim Plate Surgical Technique

## DVR Volar Rim Plate



Figure 1

### Plate Sizing

Use the plate sizing template set to determine the head width that will most closely match the patient's anatomy. Flip the template over to change from right-side to left-side orientation (Figure 1).

When selecting the appropriate plate size, choose the plate that not only captures the volar marginal fragment on the ulnar side, but also supports that entire volar distal radius, including the radial styloid, even if the radial styloid is intact.

**Note:** In situations where the comminution of the fracture makes it difficult to assess the appropriate size, use the opposite hand to establish the appropriate size to use.

DVR Volar Rim Plates are available in narrow and standard head widths.



Figure 2



Figure 3

## Plate Positioning

Determine the correct position for the plate by judging how the plate conforms to the volar surface of the radius (Figure 2). The tabs will sit distal to the watershed line.

## Plate Fixation

Recommended order for screw insertion is:

- Oblong hole in shaft of plate
- Proximal row in head of plate
- Remaining shaft holes
- Distal row in head of plate

## DVR Volar Rim Plate

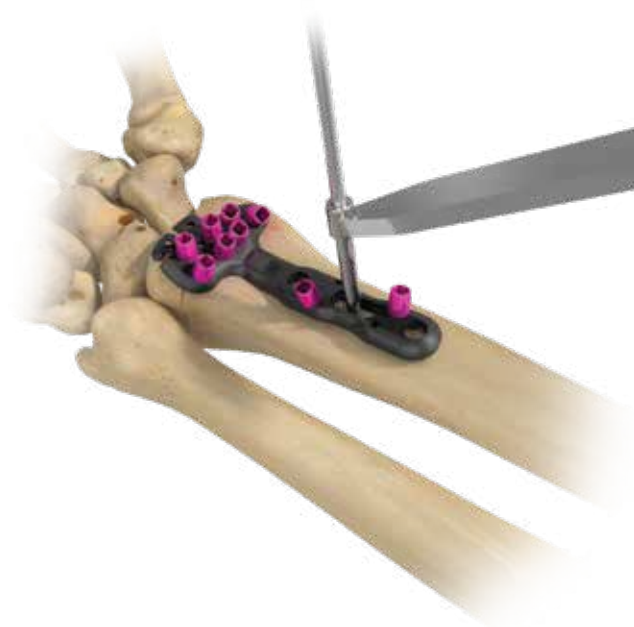

Figure 4

### Drilling for Non-Threaded Positions

The 2.2 mm drill will be used in conjunction with the 2.2 mm Locking Drill Guide. The soft tissue guide should be used when drilling through the non-threaded and oblong screw holes (Figure 4). Using the 2.2 mm drill bit with the soft tissue guide, drill through the center of the proximal oblong hole of the plate, which will allow for plate adjustments (Figure 4).

ⓘ **Note:** The soft tissue guide should not be used when drilling through the F.A.S.T. Guide insert.



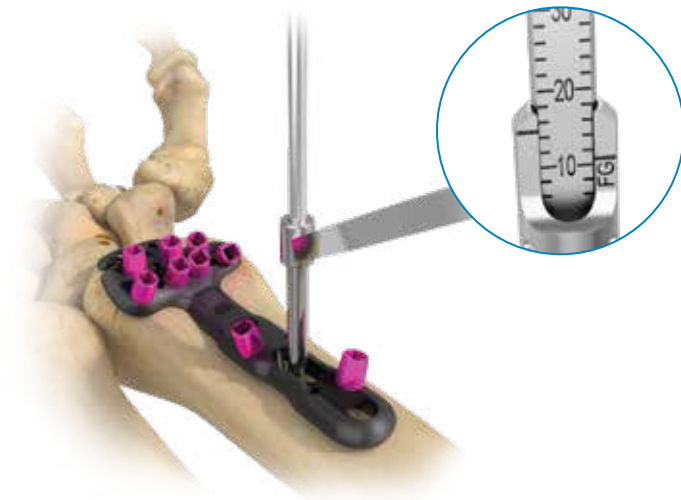

Figure 5

## Measuring for Non-Threaded Positions

When using the soft tissue guide to determine screw length, read the measurement where the marking on the drill bit aligns with the line on the soft tissue guide (Figure 5). The depth gauge can be used to verify the screw length required. The depth gauge scale will provide a direct line to line measurement. When selecting a screw for the oblong hole or any other non-threaded screw hole in the shaft, round up measurement to the nearest 1 mm or 2 mm (Figure 5). Use the non-FG line to determine the length of the screw.

- ⓘ **Note:** If using the depth gauge through the F.A.S.T. Guide insert, read the measurement from the FG mark on the depth gauge.

Insert the appropriate length 2.7 mm locking screw using the driver.

- ⓘ **Note:** The locking screws are designed to work in threaded, non-threaded, and oblong holes.



Figure 6

## Distal Plate Fixation

### Final Fracture Reduction

Final reduction is obtained by indirect means using the DVR Crosslock Distal Radius Volar Rim plate as a template, then applying traction, ligamentotaxis, and direct pressure over the dorsal aspect (Figure 6). The use of K-wires and/or a sharp hook can be used to manipulate fragments into place.

- ⓘ **Note:** A properly applied bolster helps to maintain the reduction.
- ⓘ **Note:** Visually inspect the plate to see if there is a gap between the bone and the tabs. Use fluoroscopy to help make this determination. If there is a gap, see the section titled “Bending Tabs”.
- ⓘ **Note:** If planning to use the suture holes in the distal tabs of the plate for soft tissue approximation, this is the point that this should be considered. See section titled “Tissue Approximation with Sutures”.

## DVR Volar Rim Plate

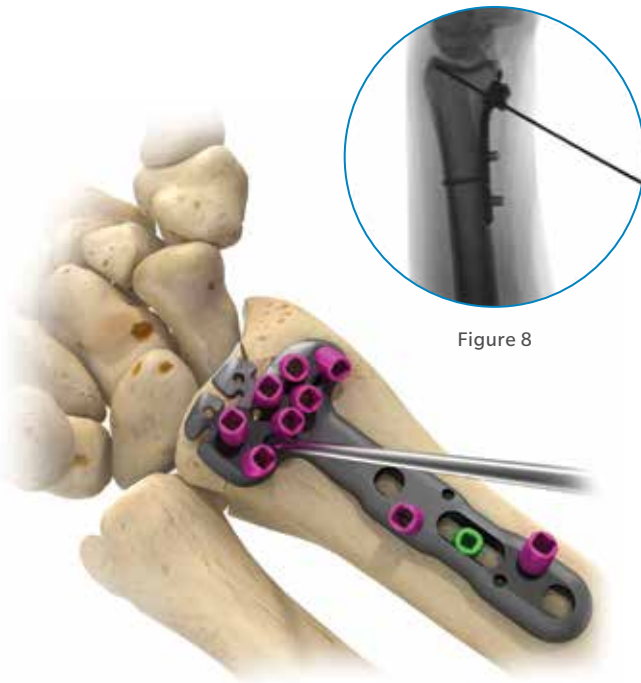

Figure 8

Figure 7



Figure 9

### Final Fracture Reduction (cont.)

First, secure the distal fragment to the plate by inserting a K-wire through the most ulnar K-wire hole in the proximal row (Figure 7 and 8). Proper plate positioning can be confirmed using fluoroscopy by obtaining a 20–30 degree lateral image. The K-wire should be 2–3 mm subchondral to the joint line on this view.

⊖ **Note:** Bend the K-wire out of the way to facilitate drilling.

⊖ **Note:** K-wires installed in the proximal row aid in reduction of the distal fragments and allow proper assessment of screw placement prior to drilling.

### Drilling the Proximal Row

Using the 2.2 mm drill bit, drill through the proximal F.A.S.T. Guide inserts starting on the ulnar side in order to stabilize the lunate fossa (Figure 9).

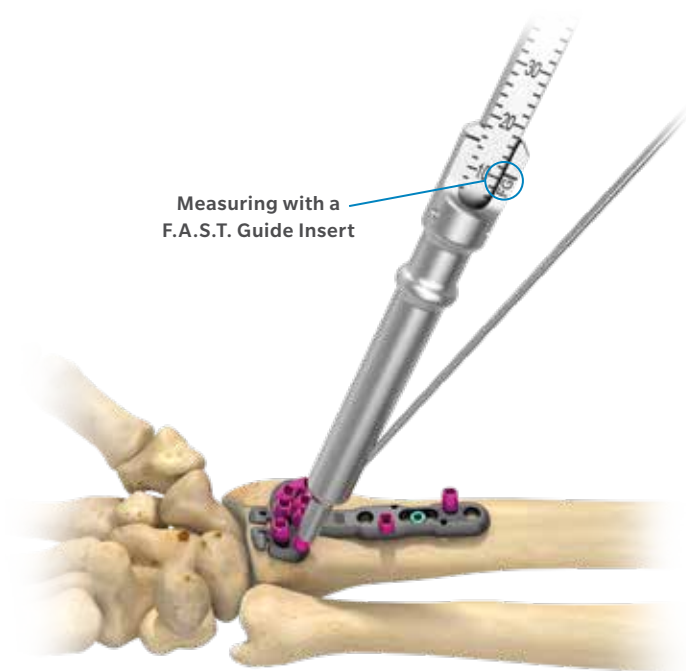

Figure 10

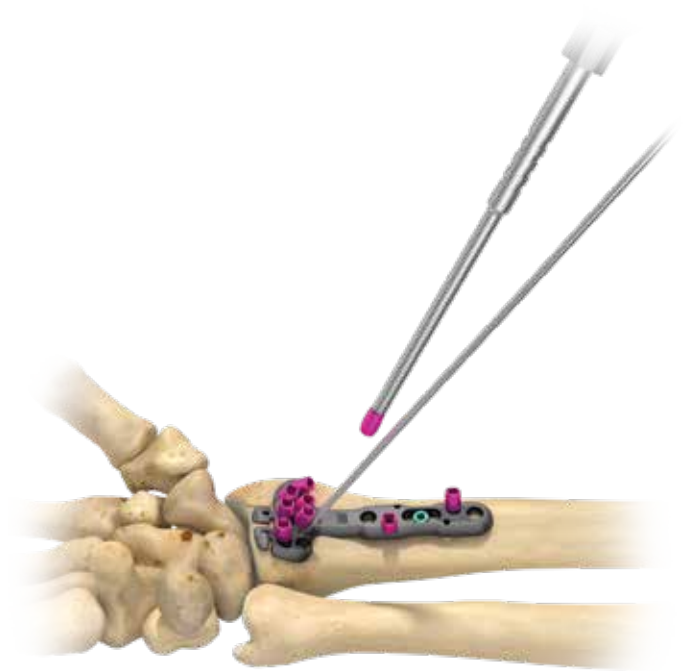

Figure 11

## Measuring Through the F.A.S.T. Guide Insert

Measure the drilled hole with the depth gauge by taking a direct reading from the FG line (Figure 10).

The depth gauge calibration will provide a direct measurement. When selecting screws in the metaphysis, choosing a screw 1 mm or 2 mm less than the reading may reduce the risk of tissue irritation.

**Note:** If the F.A.S.T. Guide insert is removed before measuring the screw length, use the line closest to the edge of the depth gauge.

## Removing the F.A.S.T. Guide Inserts

Remove each F.A.S.T. Guide insert with the square driver after checking the drilled depth (Figure 11).

## DVR Volar Rim Plate



Figure 12

### Inserting Locking Screws in Proximal Row

Using the same driver, fill the holes in the head of the plate with the appropriate length locking screws (Figure 12).

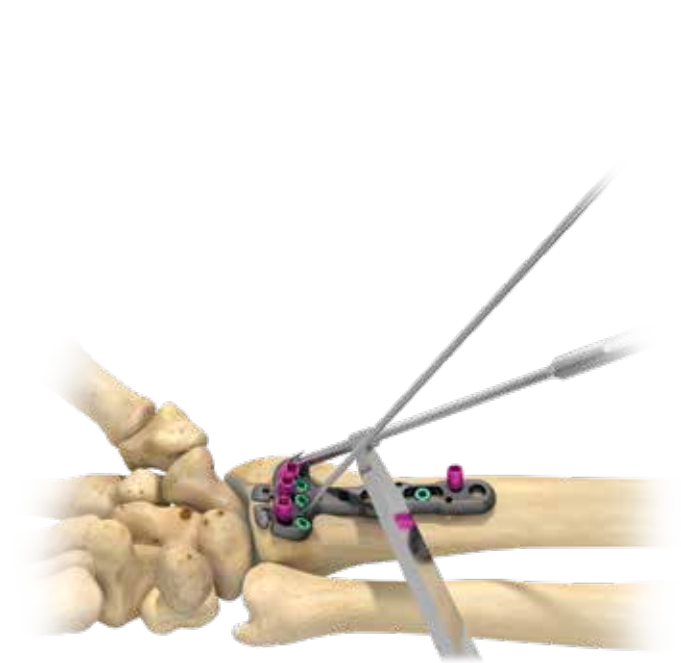

Figure 13

### Inserting a Multi-Directional Screw (MDS)

A MDS option is available for locked fixation within a 20 degree cone of angulation off the fixed angle trajectory. Remove the F.A.S.T. Guide inserts using the square driver. Place the 2.2 mm end of the soft tissue guide into the screw hole. Place the 2.2 mm drill bit through the soft tissue guide until it comes in contact with the bone. Determine the trajectory of the drill bit by varying the angle of the soft tissue guide and drill (Figure 13).

ⓘ **Note:** A MDS can be used in any threaded locking hole.

ⓘ **Note:** Fluoroscopy should be used to avoid placing a MDS in the intra-articular joint space.



Figure 14



Figure 15

## Final Plate Fixation

### Inserting the Remaining Shaft Screws

After inserting the proximal row of locking screws, go back to the shaft of the plate and fill the non-threaded holes first, using the same technique that was used for the oblong hole (Figure 14). The locking screws will act as a non-locking screw in the non-threaded holes. Next, fill the crosslocking holes in the shaft, which are angled locking screw holes with F.A.S.T. Guide inserts. Use the same technique as applying locking screws in the distal end of the plate.

### Inserting the Distal Row Screws

Since the distal row of the head of the plate converges on the proximal row between 14 mm and 18 mm, typically a 16 mm length screw is all that is needed in the distal row (Figure 15). Remove all F.A.S.T. Guide inserts, even if the screw hole is not used.

- Note:** The proximal row provides support to the dorsal aspect of the articular surface. The distal row provides support to the central and volar aspects of the subchondral plate.

## DVR Volar Rim Plate



Figure 16



Figure 17

### Bending F.A.S.T. Tabs Technology

The plate should match the anatomy fairly well. If there is a visible gap between the volar marginal fragment and the distal tabs of the plate, the blunt end of the K-wire should be used to bend the tabs downward onto the bone (Figure 16). Each tab can be bent up to 20 degrees (Figure 17).

- ⓘ **Caution:** Tabs are meant to be bent in a downward motion. Once the tab makes contact with the bone, no more torque should be applied since it could damage the bone. At least one screw should be installed in the head of the plate before the tabs are manipulated.
- ⓘ **Note:** Do not insert K-wire into tab hole for bending once sutures are installed; it may compromise the load-carrying capability of the suture.





Figure 18



Figure 19



Figure 20

## Tissue Approximation with Sutures

4–0, 3–0, and 2–0 MaxBraid™ PE sutures are suitable for use with the DVR Crosslock Distal Radius Volar Rim Plating System plate. With the plate only provisionally fixed to the bone with a screw in the shaft of the plate, first pass the suture through the tissues of the distal fragment, such as the short radiolunate ligament, then pass it through the hole of the tab from the bottom up (Figure 18). Subsequently, pass the suture over the hole of the second tab and secure by tying the knot below or beside the tabs (Figures 19 and 20).

- ⓘ **Note:** Make sure fragment is reduced before applying suture.
- ⓘ **Note:** If tabs are expected to be bent to match patient anatomy, perform bending process prior to suture installation. Inserting the k-wire into a hole that has a suture installed may compromise the load-carrying capability of the suture.
- ⓘ **Note:** If any locking screws have been previously installed, partial removal of these screws may be required to allow suture needle to pass through holes on the tabs.

## DVR Volar Rim Plate

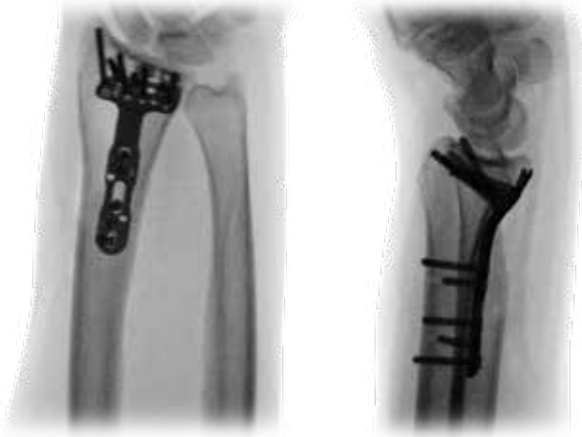

Figure 21



Figure 22

### Final Radiographs

A 20–30 degree elevated lateral fluoroscopic view allows visualization of the articular surface, evaluation of the volar tilt, and confirmation of proper screw placement 2–3 mm proximal to the subchondral surface (Figure 21).

To confirm that the length of each individual screw is correct, pronate and supinate the wrist under fluoroscopy.

### Final Appearance

A properly applied plate should have the F.A.S.T. Tabs Technology distal to the watershed line (Figure 22).

ⓘ **Note:** Ensure all F.A.S.T. Guide inserts are removed prior to closing.

### Wound Closure

Repair the transitional fibrous zone (TFZ) in order to cover the distal edge of the plate. Repair the brachioradialis. Suture the pronator quadratus muscle (PQ) to the transitional fibrous zone (TFZ) and the repaired brachioradialis.



## Post-Operation Consideration

Flexor tendon rupture after volar plating of the distal radius is a complication that is infrequent but possible. Implant prominence at the watershed line may increase the risk of tendon injury.<sup>3</sup> The two tabs on this plate are designed to provide additional support to volar radius fractures with distal fragments and to subsequently cross the watershed line. The surgeon should take this into consideration during subsequent follow-up of the patient to determine if plate removal post-healing is warranted.





## DVR Wrist Plates Surgical Technique

## DVR Wrist Plates

### Approach - Incision

Use the required approach for your patient's needs.

#### Dorsal:

1. Incision over Lister's Tubercle
2. Retract Extensor Pollicis Longus Tendon towards the radial styloid



#### Radial Styloid:

1. Incision over Lister's Tubercle
2. Plate is to be slid under first compartment of tendons



#### Distal Ulna:

1. Arm should be at neutral rotation before incision is made; incision is made between the Flexor Carpi Ulnaris and Extensor Carpi Ulnaris
2. Dorsal Cutaneous Ulnar Nerve and the Extensor Carpi Ulnaris need to be avoided



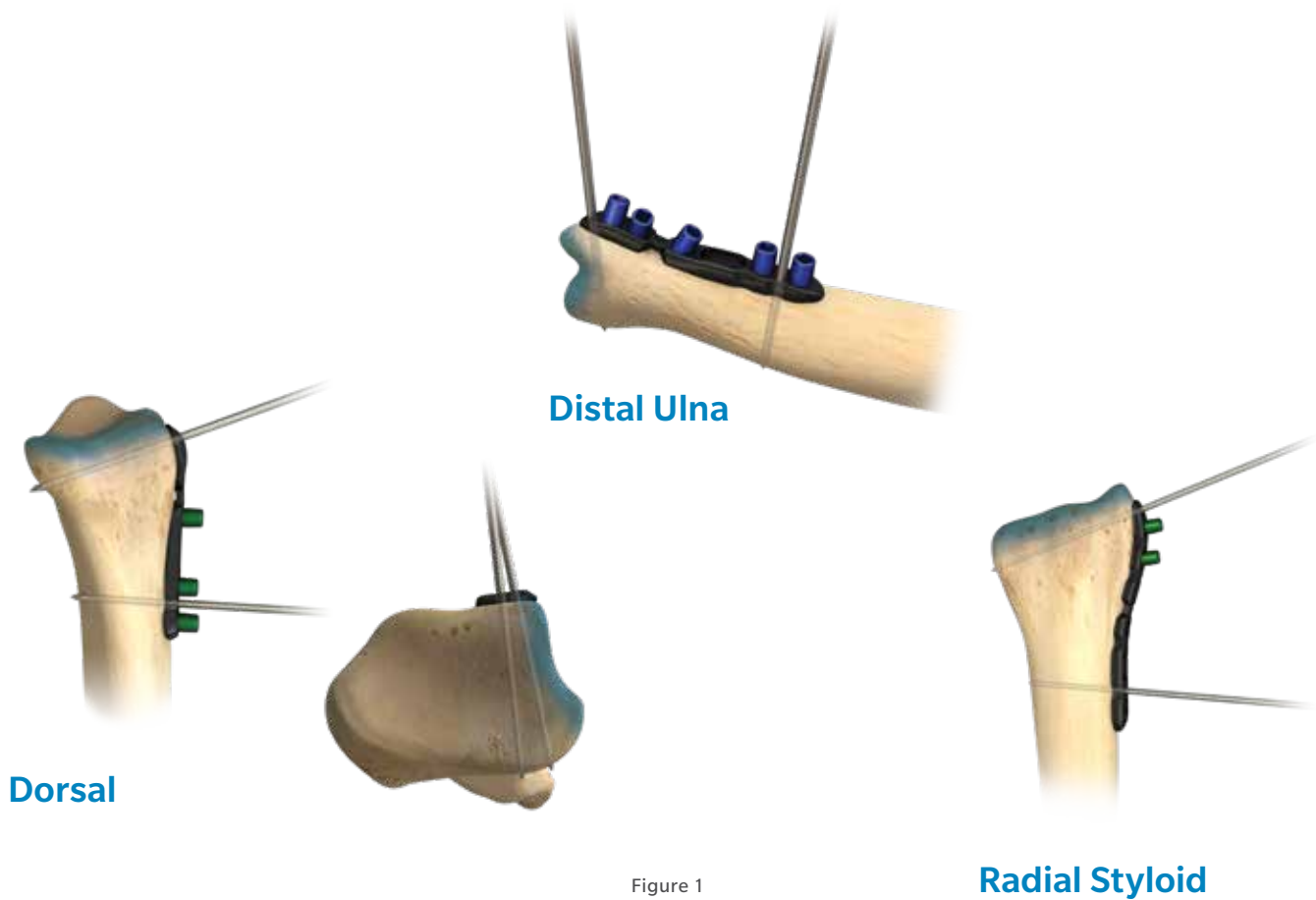

Figure 1

## Provisional Fixation

### Temporary Fixation and Plate Placement Confirmation

After the fracture has been reduced, insert K-wire through distal K-wire hole (Figure 1). Use fluoroscopy to visually confirm that K-wire is not in the joint. Properly placed K-wires will be 2–3 mm from joint spaces. This will confirm that screw trajectories will not penetrate the joint space.

⊖ **Note:** The second K-wire hole in the head of the Dorsal plate will indicate that K-wire is not in the sigmoid notch. See images above.

For temporary fixation in the shaft, insert K-wire through the K-wire hole.

⊖ **Note:** A K-wire adapter is available for temporary fixation in any threaded hole position with a pre-installed F.A.S.T. Guide insert.

⊖ **Note:** F.A.S.T. Guide inserts are not present on the shaft of the radial styloid plate to allow plate to be slid under the first compartment of tendons.

## DVR Wrist Plates

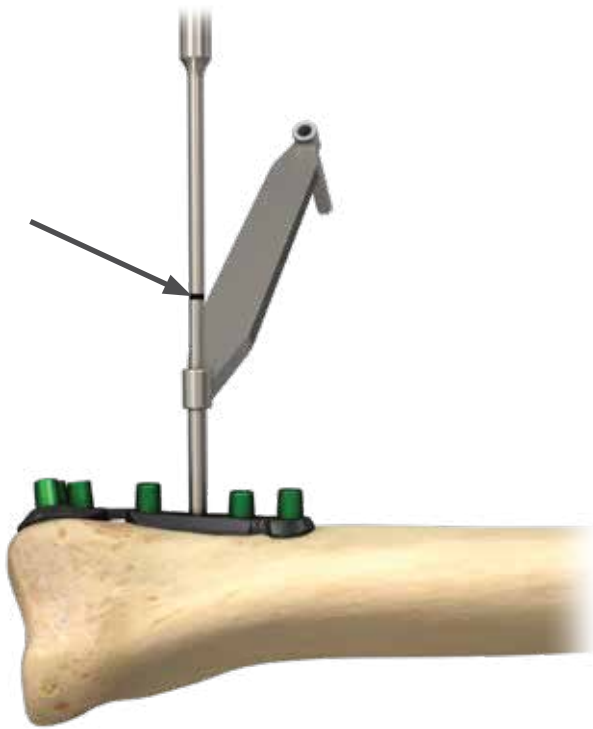

Dorsal

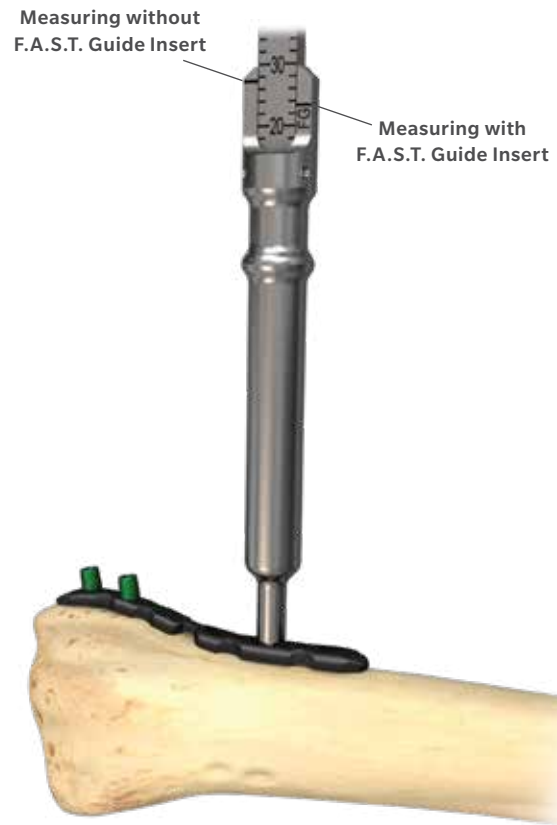

Radial Styloid

Figure 2

## Screw Selection

Typical measurement through non-threaded position.

### Measuring for Non-Threaded Positions

1. When using the soft tissue guide to determine screw length, read the measurement where the marking on the drill bit aligns with the line on the soft tissue guide (Figure 2).
2. When selecting a screw for the oblong hole, the surgeon may want to round up to get bi-cortical purchase.

ⓘ **Note:** If using the depth gauge through the F.A.S.T. Guide insert, read the measurement from the FG mark on the depth gauge.

Insert the appropriate length 2.7 mm locking screw using the driver.

ⓘ **Note:** The locking screws are designed to work in threaded, non-threaded and oblong holes.

## Combination Plating

For fractures that require the use of both a dorsal and a radial styloid plate, it is recommended to apply the dorsal plate first.





Figure 3  
Dorsal

## Recommended Screw Order

### Recommended order for inserting screws

Insert screws based on measurement and recommended screw order. Ensure that oblong hole is inserted bi-cortically (Figure 3).

### Recommended Order:

1. Oblong hole in shaft of plate
2. Head of plate
3. If plate contouring is required  
see Plate Contouring Section on page 47.
4. Remaining shaft holes

## DVR Wrist Plates

Dorsal



Radial Styloid

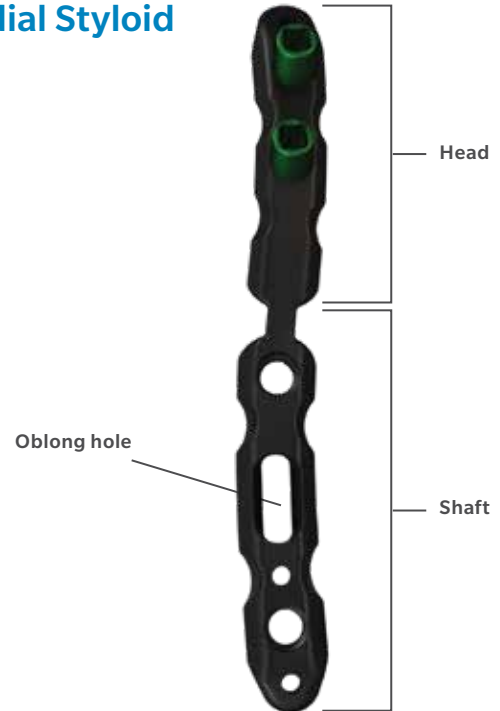

Distal Ulna

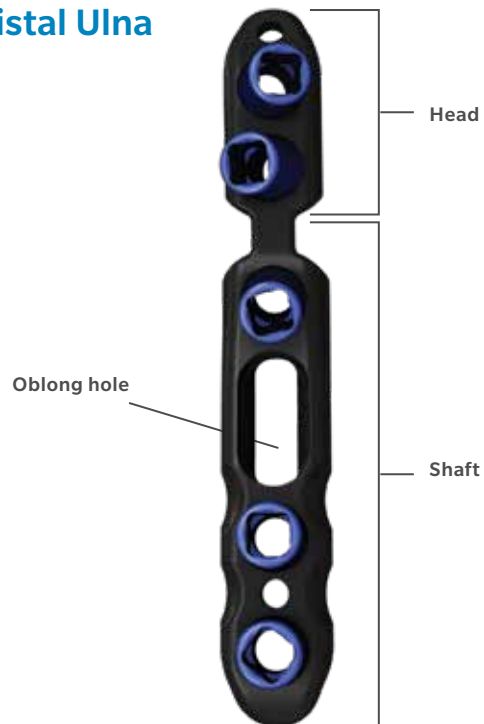



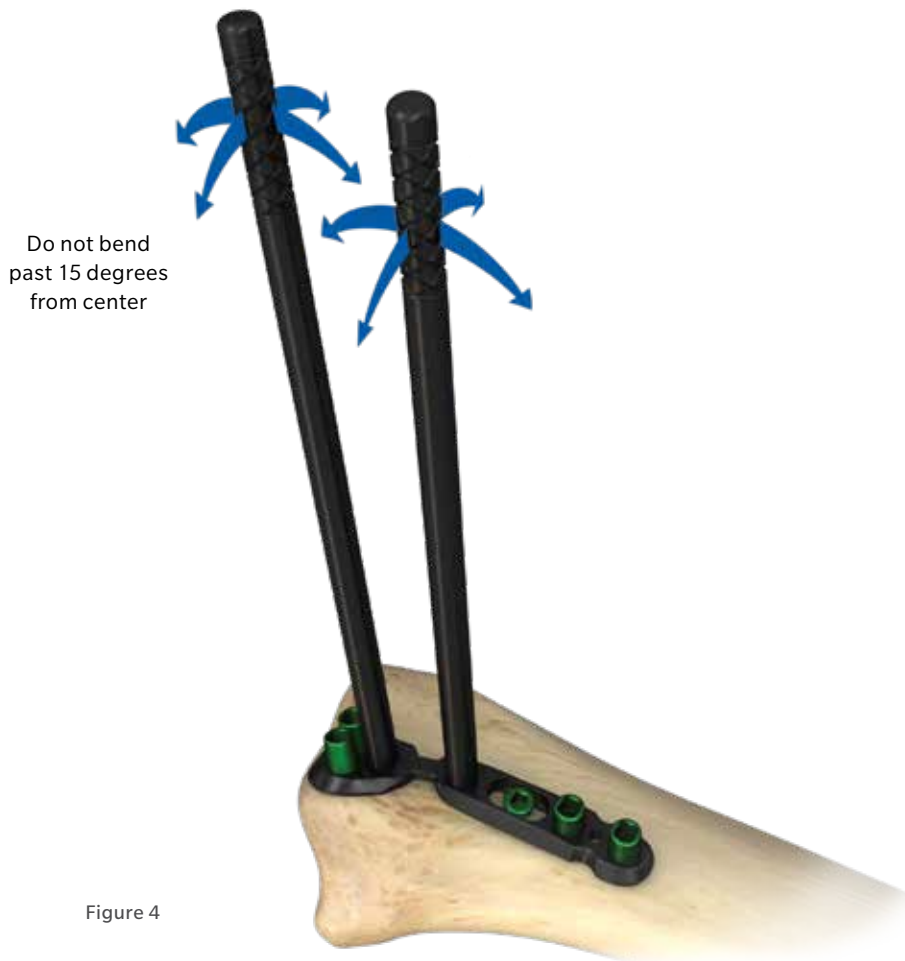

Figure 4

## Plate Contouring

### Contouring of Plate In-Situ

The plates are designed to closely match the anatomy. In cases where there is variation in the bone, these plates can be further contoured intra-operatively at the bridge region. Remove F.A.S.T. Guide Inserts adjacent to bend feature in order to thread benders (Figure 4). Plates can be bent in the coronal plane and twisted in the axial plane by utilizing the plate benders. After plate has been bent, insert F.A.S.T. Guide Inserts back into threaded holes. The plate benders are located in the DVR Crosslock Wrist Tray Module.

### Inserting a Multi-Directional Screw (MDS)

A Multi-Directional Screw option is available for locked fixation within a 20 degree cone of angulation off the fixed angle trajectory in any locked hole.

ⓘ **Note:** Fluoroscopy should be used to avoid placing the MDS in the intra-articular joint space.

## DVR Wrist Plates

### Dorsal

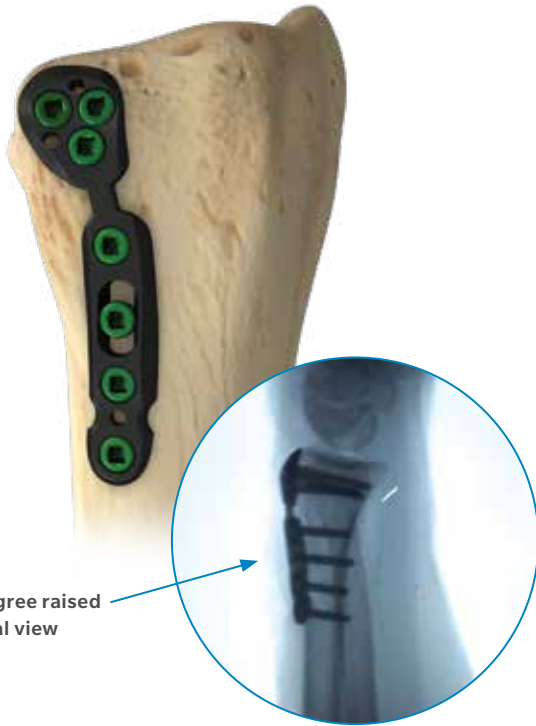

### Radial Styloid



Figure 5

### Final Appearance

Fluoroscopic imaging allows visualization of the articular surface, evaluation of the reduction and confirmation of proper screw placement. All screws must be flush in plate. To confirm that the length of each individual screw is correct, pronate and supinate the wrist under fluoroscopy. A properly applied plate should be flush with the bone while capturing the fragments (Figure 5).

**Note:** Remember to remove the F.A.S.T. Guide inserts.

### Distal Ulna



## Ordering Information - Instruments

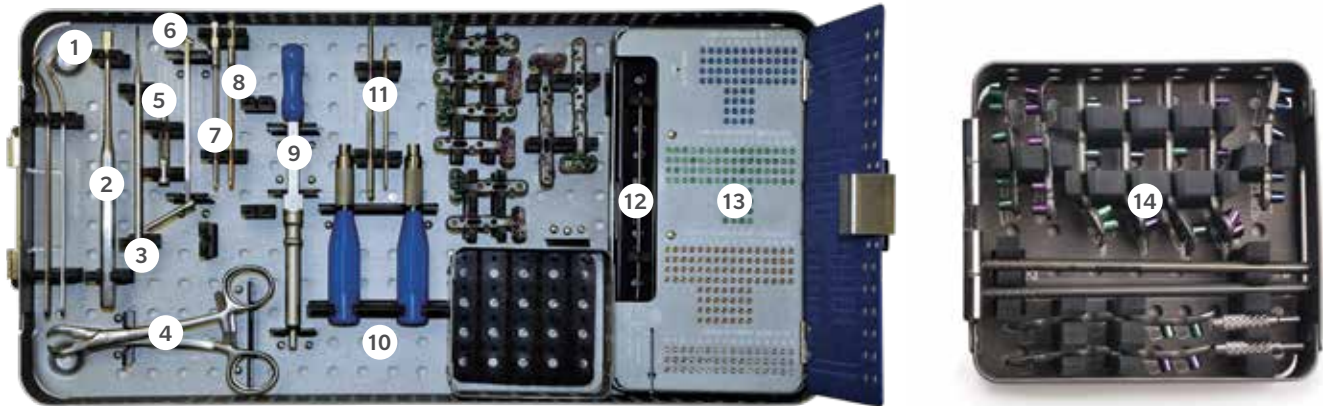



### DVR Crosslock Modular Tray

Fully modular tray system addresses multiple applications with the use of a single tray.

Product	Description	Label	Part Number
Instruments	Mini Hohmann Retractors	1	MHR
	Key Elevator	2	2312-00-112
	Sharp Hook	3	9399-99-280
	Bone Clamp DRT	4	BC
	Stagbeetle Forceps	4	93-9999-518
	2.2 mm Locking Drill Guide	5	2312-00-109
	2.2/2.9 mm Soft Tissue Guide	6	2312-00-104
	2.2 mm Drill Bit	7	2312-00-200
	2.9 mm Drill Bit (Overdrill)	8	2312-00-201
	Bone Depth Gauge	9	2312-00-100
	Quick Connect Handle Blue	10	2312-00-106
	1.7/2.2 mm Square Driver	11	2312-00-101
	1.6 mm K-Wire Stainless Steel	12	KW062SS
	2.7 mm Threaded Bender	-	2312-00-107
	1.6 mm K-Wire Adapter	-	2312-00-105
Plate Sizing Template	-	2120-00-010	
Trays and Caddies	DVR Crosslock Complete Case and Tray	-	2312-00-001
	DVR Crosslock Screw Caddy	13	2312-00-004
	DVR Crosslock Wrist Tray	14	2312-00-006

## Ordering Information - Implants

### DVR Crosslock Plates



Product	Size	Description	Non-Sterile	Sterile
<b>Narrow Mini Locked Plate</b> 	22 mm X 41 mm	Right Left	1318-11-040 1318-21-040	1318-11-041 1318-21-041
<b>Extra Narrow Locked Plate</b> 	19 mm X 50 mm	Right Left	1318-10-050 1318-20-050	1318-10-051 1318-20-051
<b>Mini Locked Plate</b> 	24 mm X 43 mm	Right Left	1318-12-040 1318-22-040	1318-12-041 1318-22-041
<b>Narrow Locked Plate</b> 	22 mm X 51 mm	Right Left	1318-11-050 1318-21-050	1318-11-051 1318-21-051
<b>Standard Locked Plate</b> 	24 mm X 51 mm	Right Left	1318-12-050 1318-22-050	1318-12-051 1318-22-051
<b>Wide Locked Plate</b> 	28 mm X 56 mm	Right Left	1318-13-050 1318-23-050	1318-13-051 1318-23-051
<b>Medium Locked Plate</b> 	24 mm X 62 mm	Right Left	1318-12-060 1318-22-060	1318-12-061 1318-22-061
<b>Long Locked Plate</b> 	24 mm X 85 mm	Right Left	1318-12-090 1318-22-090	1318-12-091 1318-22-091

Right plates are shown.

## Ordering Information - Implants (cont.)

Sterile Single Pack Only

### DVR Crosslock Plates

Product	Size	Description	Sterile
 Extra Long Locked Plate	24 mm X 125 mm	Right	1318-12-126
		Left	1318-22-126
 Extra Extra Long Locked Plate	24 mm X 175 mm	Right	1318-12-176
		Left	1318-22-176

### 3.5 mm Locking Screws

Product	Size	Non-Sterile	Sterile
 3.5 mm Locking Screws	8 mm	-	1318-35-108
	10 mm	-	1318-35-110
	12 mm	-	1318-35-112
	14 mm	-	1318-35-114
	16 mm	-	1318-35-116
	18 mm	-	1318-35-118
	20 mm	-	1318-35-120
	22 mm	-	1318-35-122
	24 mm	-	1318-35-124
	26 mm	-	1318-35-126
	28 mm	-	1318-35-128
	30 mm	-	1318-35-130

### Instruments

Product	Description	Label	Part Number
Instruments	2.7 mm Drill Bit STE	-	2120-00-027
	2.7 Soft Tissue Drill Guide STE	-	2120-00-127
	Soft Tissue Guide 2.7 mm	-	2120-00-227
	Long Plate Bender with Two Slots	-	2120-00-005

**Note:** The 2.7 Drill, Drill Guide and Soft Tissue Drill Guides are available in sterile single pack.

## Ordering Information - Implants (cont.)

### DVR Screws

Product	Size	Non-Sterile	Sterile
<b>2.2 mm Locking Smooth Pegs</b> 	8 mm	1312-27-008	-
	9 mm	1312-27-009	-
	10 mm	1312-27-010	-
	11 mm	1312-27-011	-
	12 mm	1312-27-012	-
	13 mm	1312-27-013	-
	14 mm	1312-27-014	1318-27-014
	15 mm	1312-27-015	-
	16 mm	1312-27-016	1318-27-016
	18 mm	1312-27-018	1318-27-018
	20 mm	1312-27-020	1318-27-020
	22 mm	1312-27-022	1318-27-022
	24 mm	1312-27-024	1318-27-024

<b>2.7 mm Locking Screws</b> 	8 mm	1312-27-108	-
	9 mm	1312-27-109	-
	10 mm	1312-27-110	1318-27-110
	11 mm	1312-27-111	-
	12 mm	1312-27-112	1318-27-112
	13 mm	1312-27-113	-
	14 mm	1312-27-114	1318-27-114
	15 mm	1312-27-115	-
	16 mm	1312-27-116	1318-27-116
	18 mm	1312-27-118	1318-27-118
	20 mm	1312-27-120	1318-27-120
	22 mm	1312-27-122	1318-27-122
	24 mm	1312-27-124	1318-27-124

<b>2.7 mm Multi-Directional Screws</b> 	8 mm	1312-27-308	-
	9 mm	1312-27-309	-
	10 mm	1312-27-310	1318-27-310
	11 mm	1312-27-311	-
	12 mm	1312-27-312	1318-27-312
	13 mm	1312-27-313	-
	14 mm	1312-27-314	1318-27-314
	15 mm	1312-27-315	-
	16 mm	1312-27-316	1318-27-316
	18 mm	1312-27-318	1318-27-318
	20 mm	1312-27-320	1318-27-320
	22 mm	1312-27-322	1318-27-322
	24 mm	1312-27-324	1318-27-324

Product	Size	Non-Sterile	Sterile
<b>2.7 mm Non-Locking Screws</b> 	8 mm	1312-27-208	-
	9 mm	1312-27-209	-
	10 mm	1312-27-210	1318-27-210
	11 mm	1312-27-211	-
	12 mm	1312-27-212	1318-27-212
	13 mm	1312-27-213	-
	14 mm	1312-27-214	1318-27-214
	15 mm	1312-27-215	-
	16 mm	1312-27-216	1318-27-216
	18 mm	1312-27-218	1318-27-218
	20 mm	1312-27-220	1318-27-220
	22 mm	1312-27-222	1318-27-222
	24 mm	1312-27-224	1318-27-224



26 mm	1312-27-226	1318-27-226
28 mm	1312-27-228	1318-27-228
30 mm	1312-27-230	1318-27-230

## Ordering Information - Implants (cont.)

### DVR Wrist Plates

Product	Description	Non-Sterile	Sterile
 Dorsal Plate	Right	1318-17-050	1318-17-051
	Left	1318-27-050	1318-27-051
 Radial Styloid Plate	Right	1318-18-060	1318-18-061
	Left	1318-28-060	1318-28-061
 Ulna Plate	Unilateral	1318-39-050	1318-39-051

### DVR Volar Rim Plates

Product	Description	Non-Sterile	Sterile
 DVR Volar Rim	Right	1318-14-050	1318-14-051
	Left	1318-24-050	1318-24-051
 DVR Volar Rim Narrow	Right	1318-15-050	1318-15-051
	Left	1318-25-050	1318-25-051

## DVR Crosslock

### INDICATIONS

The system is intended for fixation of fractures, malunions and osteotomies involving the distal radius.

### WARNINGS AND PRECAUTIONS

- Do NOT open the volar wrist capsule. Doing so may cause devascularization of the fracture fragments and destabilization of the volar wrist ligaments.
- If necessary, contour the plate in small increments. Excessive contouring may weaken or fracture the plate.
- Do NOT use screw lengths that will excessively protrude through the far cortex. Protrusion through the far cortex may result in soft tissue irritation.
- Do NOT permanently implant K-wires through the holes of the plate as they may back out and cause tissue damage. Use of the K-wires allows you to provisionally secure the plates to the anatomy.
- Foreign body sensitivity – where material sensitivity is suspected, appropriate tests should be made and sensitivity ruled out prior to implantations.
- Cases where the implant(s) would cross open epiphyseal plates in skeletally immature patients.
- Cases with malignant primary or metastatic tumors which preclude adequate bone support or screw fixations, unless supplemental fixation or stabilization methods are utilized.

**NOTE:** It is NOT required to remove the F.A.S.T. Guide inserts to sterilize the plate.

### CONTRAINDICATIONS

Contraindications (orthopaedic screws, intramedullary nails, plates, compression hip screws, pins and wires):

- Cases where there is an active infection.
- Conditions which tend to retard healing such as, blood supply limitations, previous infections, etc.
- Insufficient quantity or quality of bone to permit stabilization of the fracture complex and/or fusion of the joints.
- Conditions that restrict the patient's ability or willingness to follow postoperative instructions during the healing process.



## DVR Volar Rim

### INDICATIONS

The system is intended for fixation of fractures, malunions and osteotomies involving the distal radius.

### WARNINGS AND PRECAUTIONS

- Do NOT open the volar wrist capsule. Doing so may cause devascularization of the fracture fragments and destabilization of the volar wrist ligaments.
- If necessary, contour the plate in small increments. Excessive contouring may weaken or fracture the plate.
- Do NOT use screw lengths that will excessively protrude through the far cortex. Protrusion through the far cortex may result in soft tissue irritation.
- Do NOT permanently implant K-wires through the holes of the plate as they may back out and cause tissue damage. Use of the K-wires allows you to provisionally secure the plates to the anatomy.
- Foreign body sensitivity – where material sensitivity is suspected, appropriate tests should be made and sensitivity ruled out prior to implantations.
- Cases where the implant(s) would cross open epiphyseal plates in skeletally immature patients.
- Cases with malignant primary or metastatic tumors which preclude adequate bone support or screw fixations, unless supplemental fixation or stabilization methods are utilized.

**NOTE:** It is NOT required to remove F.A.S.T. Guide inserts to sterilize the plate.

### CONTRAINDICATIONS

Contraindications (orthopaedic screws, intramedullary nails, plates, compression hip screws, pins and wires):

- Cases where there is an active infection.
- Conditions which tend to retard healing such as, blood supply limitations, previous infections, etc.
- Insufficient quantity or quality of bone to permit stabilization of the fracture complex and/or fusion of the joints.
- Conditions that restrict the patient's ability or willingness to follow postoperative instructions during the healing process.

## DVR Wrist Plates

### INDICATIONS FOR USE

The system is intended for stabilization and fixation of small bone fragments in fresh fractures, revision procedures, joint fusion and reconstructions (osteotomies) of small bones of the hand, foot, radius, ulna, ankle, humerus, scapula and pelvis, particularly in osteopenic bone.

### CONTRAINDICATIONS

Contraindications (orthopaedic screws, intramedullary nails, plates, compression hip screws, pins and wires):

- Cases where there is an active infection.
- Conditions which tend to retard healing such as, blood supply limitations, previous infections, etc.
- Insufficient quantity or quality of bone to permit stabilization of the fracture complex and/or fusion of the joints.
- Conditions that restrict the patient's ability or willingness to follow postoperative instructions during the healing process.
- Foreign body sensitivity – where material sensitivity is suspected, appropriate tests should be made and sensitivity ruled out prior to implantations.
- Cases where the implant(s) would cross open epiphyseal plates in skeletally immature patients.
- Cases with malignant primary or metastatic tumors which preclude adequate bone support or screw fixations, unless supplemental fixation or stabilization methods are utilized.



## References

1. Chung, Kevin C. *et al.* Treatment of Unstable Distal Radial Fractures with the Volar Locking Plating System. *Journal of Bone and Joint Surgery.* 88:2687-2693.
2. Orbay, Jorge L. *et al.* Volar Fixed-Angle Plate Fixation for Unstable Distal Radius Fractures in the Elderly Patient. *The Journal of Hand Surgery.* 29:96-102.
3. Soong, Maximilian, *et al.* Volar Locking Plate Implant Prominence and Flexor Tendon Rupture. *Journal of Bone and Joint Surgery.* 93:328-335.

All content herein is protected by copyright, trademarks and other intellectual property rights owned by or licensed to Zimmer Biomet or its affiliates unless otherwise indicated, and must not be redistributed, duplicated or disclosed, in whole or in part, without the express written consent of Zimmer Biomet. This material is intended for health care professionals, Zimmer Biomet employees and the Zimmer Biomet sales force. Distribution to any other recipient is prohibited.

Check for country product clearances and reference product specific instructions for use. For complete product information, including indications, contraindications, warnings, precautions, and potential adverse effects, see the package insert and [www.zimmerbiomet.com](http://www.zimmerbiomet.com) or contact your local Zimmer Biomet representative.

Zimmer Biomet does not practice medicine. This technique was developed in conjunction with a health care professionals. This document is intended for surgeons and is not intended for laypersons. Each surgeon should exercise his or her own independent judgment in the diagnosis and treatment of an individual patient, and this information does not purport to replace the comprehensive training surgeons have received. As with all surgical procedures, the technique used in each case will depend on the surgeon's medical judgment as the best treatment for each patient. Results will vary based on health, weight, activity and other variables. Not all patients are candidates for this product and/or procedure. Caution: Federal (USA) law restricts this device to sale by or on the order of a surgeon. Rx only.

© 2018 Zimmer Biomet



### Authorized Representative

Biomet UK Ltd.  
Waterton Industrial Estate  
Bridgend, South Wales  
CF31 3XA  
UK



**ZIMMER BIOMET**

Your progress. Our promise.®



### Legal Manufacturer

Biomet Trauma  
P.O. Box 587  
56 E. Bell Drive  
Warsaw, Indiana 46581-0587  
USA

[zimmerbiomet.com](http://zimmerbiomet.com)

0301.2-GLBL-en-REV1018

0086

