

Stryker Hand Plating System



Operative technique

VariAx Hand Locking Plate Module

Profyle Hand Standard Plate Module

VariAx and VariAx 2 Screws

Stryker Hand Plating System

Contents

Indications, contraindications, warnings and precautions	3
System overview	4
Operative technique	17
Notes	33

This publication sets forth detailed recommended procedures for using Stryker devices and instruments.

It offers guidance that you should heed, but, as with any such technical guide, each surgeon must consider the particular needs of each patient and make appropriate adjustments when and as required.

A workshop training is recommended prior to performing your first surgery. Follow the instructions provided in our cleaning and sterilization guide (OT-RG-1).

All non-sterile devices must be cleaned and sterilized before use.

Multi-component instruments must be disassembled for cleaning. Please refer to the corresponding assembly/disassembly instructions.

Please remember that the compatibility of different product systems has not been tested unless specified otherwise in the product labeling.

See Instructions for Use (90-01925, 90-01960, 90-03400, 90-03500, V15013, V15011) for a complete list of potential adverse effects, contraindications, warnings and precautions.

The surgeon must discuss all relevant risks including the finite lifetime of the device with the patient when necessary.

Indications, contraindications, warnings and precautions

Indications for use

The Stryker Hand Plating System is intended for use in internal fixation of the bones of the hand and wrist. Examples of these procedures may include but are not limited to replantation, lag screw techniques, joint fusions, corrective osteotomies, and the treatment of fractures.

Precautions

See package insert for warnings, precautions, adverse effects and other essential product information. The Stryker Hand Plating System has not been evaluated for safety and compatibility in the MR environment. It has not been tested for heating, migration, or image artifact in the MR environment. The safety of the Stryker Hand Plating System in the MR environment is unknown. Scanning a patient who has this device may result in patient injury.

Contraindications

- Inadequate bone quantity and quality
- Patients with active infections
- Patients with metal allergies and foreign body sensitivity
- Severely non-compliant patients with mental or neurological conditions who are unwilling or incapable of following postoperative care instructions
- Patients with limited blood supply or insufficient quality or quantity of bone
- Patients with unstable physical and / or mental health conditions

System overview

Tray layout

Modular tray design

The Stryker Hand Plating Solution consists of two modules with interchangeable inlays:

The VariAx Hand Locking Plate Module offers variable angled locking plates as well as non-locking plates and screws for 1.7mm and 2.3mm implant sizes.

The Profyle Hand Standard Plate Module offers non-locking plates and screws for 1.2mm, 1.7mm and 2.3mm implant sizes.

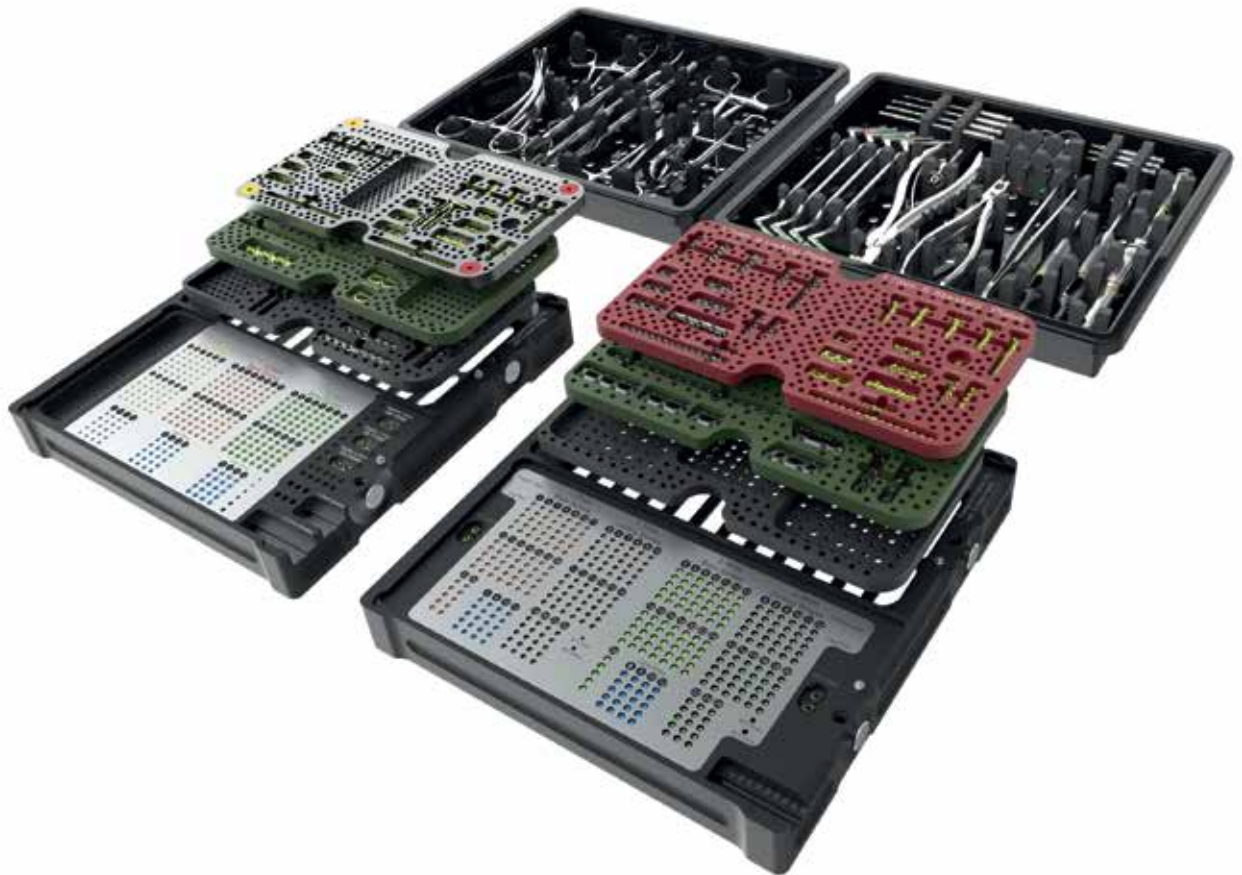

System overview

Instrumentation

Reduction instruments

These tools facilitate fracture reduction and soft tissue management.



Auerbach clamp



Lewin bone holding forceps



Lewin bone holding forceps, sharp tip



Small forceps



Lobster claw



Medium forceps



Verbrugge forceps



Hohmann retractor, 2-sided, narrow / wide



Bone hook



Periosteal elevator, 2-sided, strong curve / slight curve

Lag screw target bow

The lag screw target bow is designed to assist with fracture reduction and to achieve rigid screw fixation of the bone, when a minimally invasive incision is desired.



System overview

Instrumentation

Reduction forceps for lag screw osteosynthesis



Drill guide clamp,
curved left/right,
12.5cm



Drill guide for
1.0mm drill bit



Drill guide for
1.4mm drill bit



Drill guide for
1.9mm drill bit



Drill guide for
2.5mm drill bit



Screw guide for
1.2mm screw











Screw guide for
1.7mm screw



Screw guide for
2.3mm screw

Lag screw technique with reduction forceps:

	Step 1 Drilling of pilot hole	Step 2 Drilling of gliding hole	Step 3 Insertion of the screw
1.2mm Lag screw	Drill guide / Twist drill  1.0mm	Drill guide / Twist drill  1.4mm	Screw guide / Blade 
1.7mm Lag screw	Drill guide / Twist drill  1.4mm	Drill guide / Twist drill  1.9mm	Screw guide / Blade 
2.3mm Lag screw	Drill guide / Twist drill  1.9mm	Drill guide / Twist drill  2.5mm	Screw guide / Blade 

System overview

Instrumentation

Bender

Use the bending pliers if the plate requires additional bending. When bending the plate, take both plate bending pliers and place the bending tips of the pliers in to the holes of the plate.

NOTICE

Moderate bending of the plate will not affect the ability of the screws to lock or sit flush with the plate.

Cutter

When cutting a plate is necessary, use the cutting pliers (Ref 62-20125) and take care that the text "This Side Up" is facing up so it can be read. In the case of sharp edges after cutting a plate, an abrasive burr is available (Ref 60-80140, 60-80333, 60-80433) to smooth the edges if necessary.



System overview

Instrumentation

Screwdriver handle

The 1.2mm screws utilize the dedicated 1.2mm screwdriver handle while the 1.7mm and 2.3mm screws utilize the 1.7mm / 2.3mm screwdriver handle.



Depth gauges

The depth gauges can be utilized in a single or two-handed mode.



Taps and countersinks

When screws are used independently, screw head prominence can be reduced through the use of countersinks. Screws are all self-tapping, however taps are available in 1.2mm, 1.7mm, and 2.3mm.

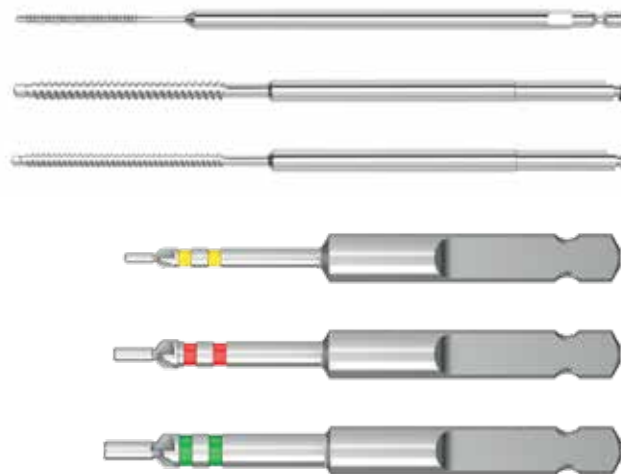



⚠ CAUTION

If excessive resistance is felt during screw insertion or if bone is dense, it is recommended to use a tap.

System overview

Instrumentation

Drill bits and guides

Screw color coding	Screw diameter	Drill guides	Interface	Drill bits diameter	Overdrill diameter
Yellow	1.2mm	1.2mm		1.0mm	1.4mm
Red	1.7mm	1.7mm		1.4mm	1.9mm
Green	2.3mm	2.3mm		1.9mm	2.5mm

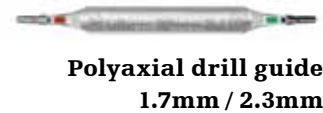
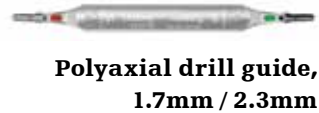
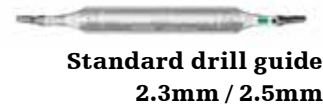
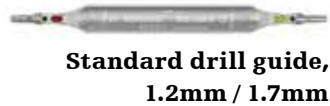
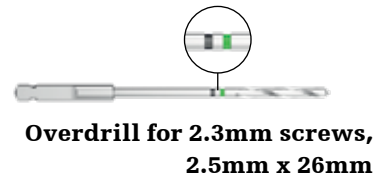
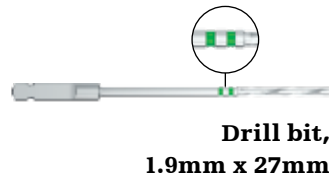
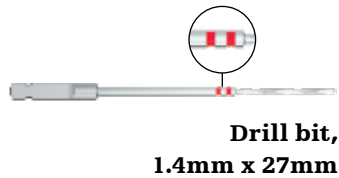
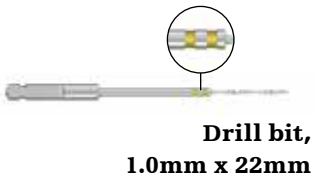

NOTICE

Color-coded indicators are located on the screw field of the Profyle Hand and VariAx Hand Modules to help identify the drill combinations used for lag screw technique of each screw size.

NOTICE

Locking drill guides must be used with all locking plates for application of bone screws and locking screws.

Note: All drill bits and countersinks are available in dental, AO, or Stryker End.

System overview

Implants: screw platform

Hand screw platform

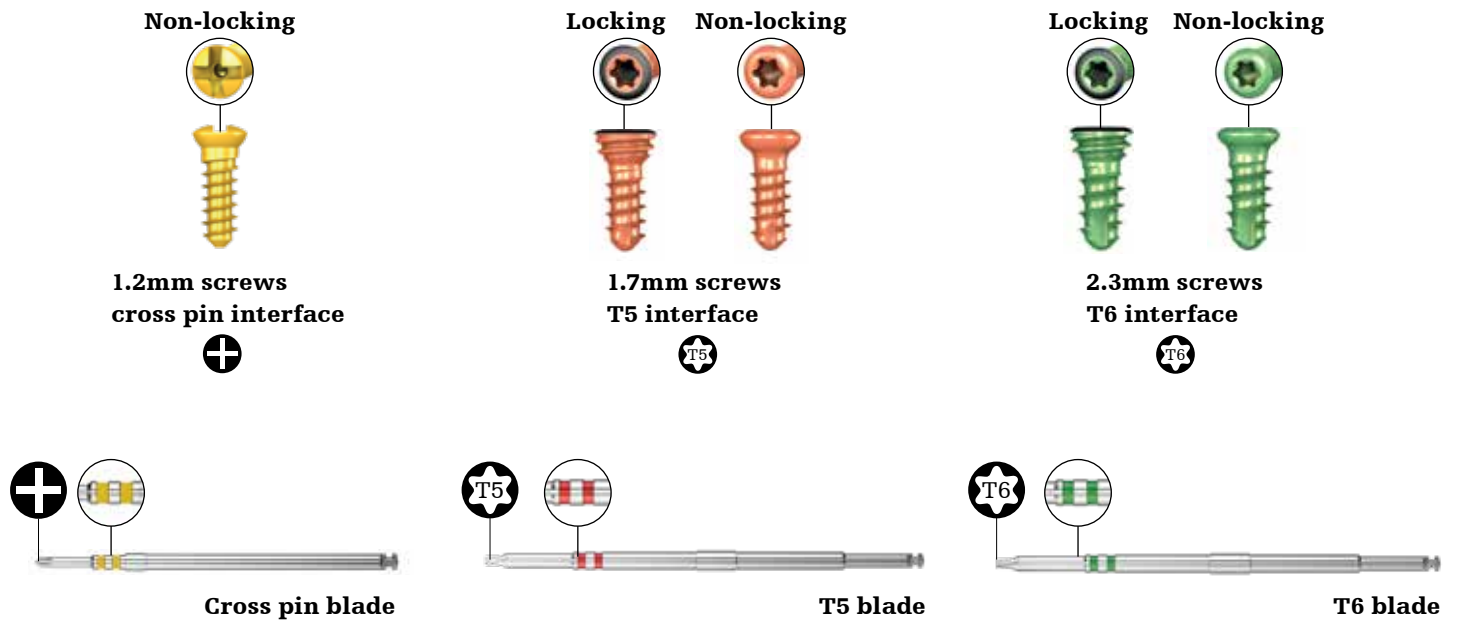

Color coding

The VariAx, 1.2mm screws and instruments and the VariAx 2, 1.7mm and 2.3mm screws and instruments follow a standardized color-coding scheme whereby the screw color matches the corresponding instrument color.

Emergency screw sizes are colored blue to differentiate from the standard screw colors, and do not match the instrument color coding.

Screw type	Lengths	Interface
1.2mm screws	4-20mm	
1.7mm screws	5-24mm	
2.3mm screws	6-40mm	

System overview

Implants: screw platform

Self-retaining screwdriver blades

All screw interfaces are self-retaining. Self-retaining screwdriver blades are designed to engage the screw head interface for safe transportation and handling.

In addition, grasping sleeves can be mounted on the blade to ensure a connection between blade and screw at all times.

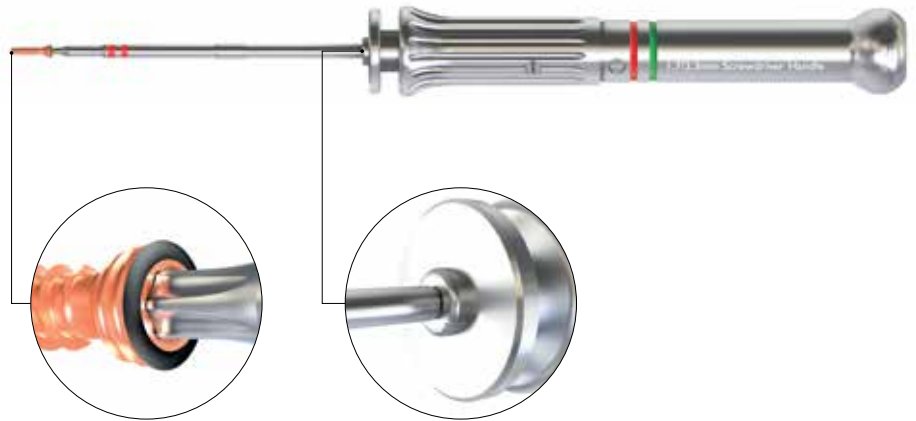

Blunt screw tips

All screws have a blunt tip and remain self tapping. This may reduce the risk of soft tissue irritation at the far cortex.



⚠ CAUTION

Insertion and final tightening of the screw should be performed by hand to avoid overtightening.



Locking



Non-locking

Locking screws are laser marked with a "dot" and "ring" marking on the screw head to differentiate them from non-locking screws.

Locking and non-locking screws

Non-locking screws are available in 1.2mm, 1.7mm and 2.3mm diameters. Polyaxial locking screws are available in 1.7mm and 2.3mm diameters. All round holes in the locking plates provide an option for locking and non-locking screws. The oblong holes provide an option for non-locking screws only.

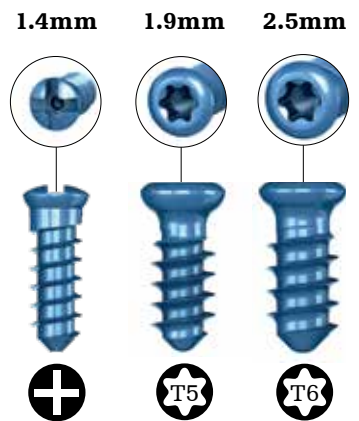

Emergency screws

These screws are available in three different sizes depending on the diameter of the initial screw used. Emergency screws are useful when initial fixation is not achieved due to poor or failed screw purchase (i.e. osteoporotic bone) and a slightly larger diameter screw might be needed.

System overview

Implants: screw platform

SmartLock technology

SmartLock technology permits polyaxial screw placement. Locking screws can be angled up to 10° in each direction for a total range of 20°. Locking plates are identifiable by the dark grey color*.

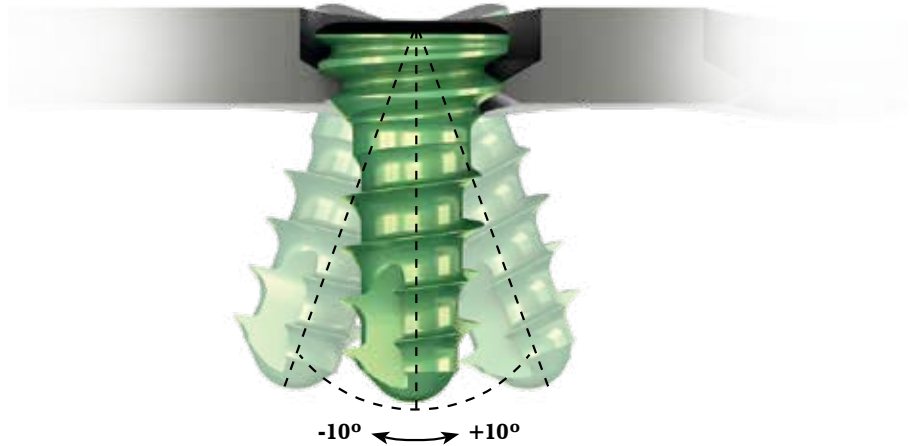

Screw length scale

A screw length scale is built into the implant modules for screw measurement. If using the grasping sleeves, a black marking on the tension plier indicates where screw measurement should be read.



Washers

Washers are available for all screw sizes when non-locking screws are used independently.

Washer for 2.3mm
T6 screws



Washer for 1.7mm
T5 screws



Washer for 1.2mm
cross pin bone screws



*SmartLock Technology is licensed from Prof. Wolter Hamburg, Germany

System overview

Implants: plate platform

1.2mm XS Profyle Hand Standard Plates



Straight plate



Straight plate



Narrow, T-plate



Narrow, T-plate



Oblique right, T-plate



Oblique, left, T-plate



Narrow, Y-plate



3D plate



3D plate



3D plate



Replantation 3D plate



3D plate

System overview

Implants: plate platform

1.7mm S VariAx Hand Locking Plates

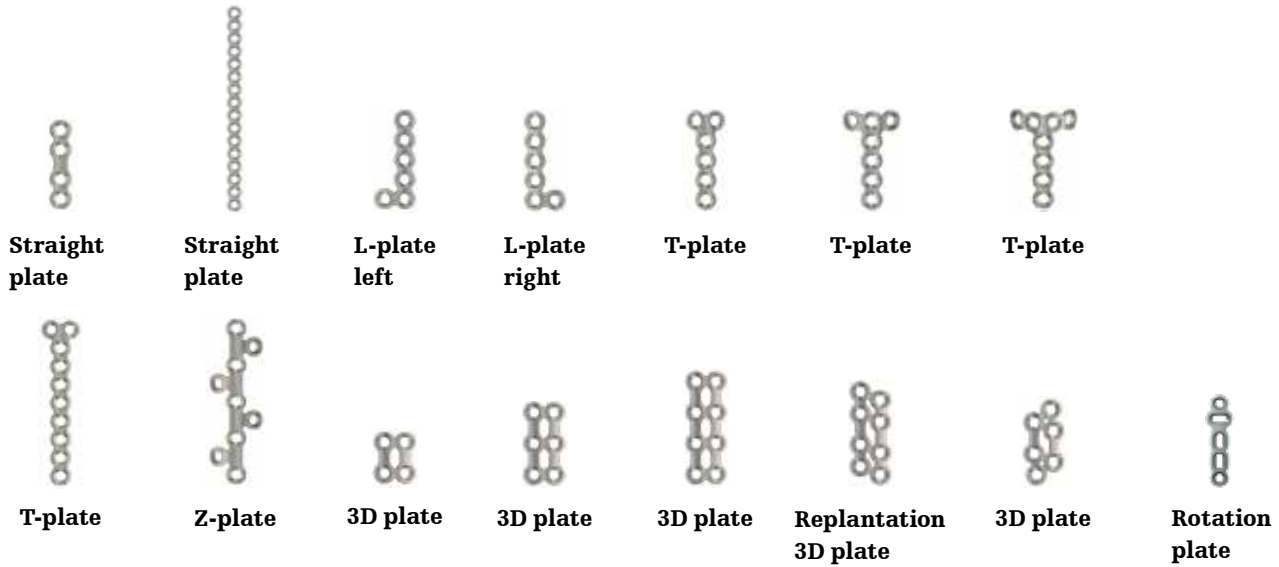

1.7mm S Profyle Hand Standard Plates

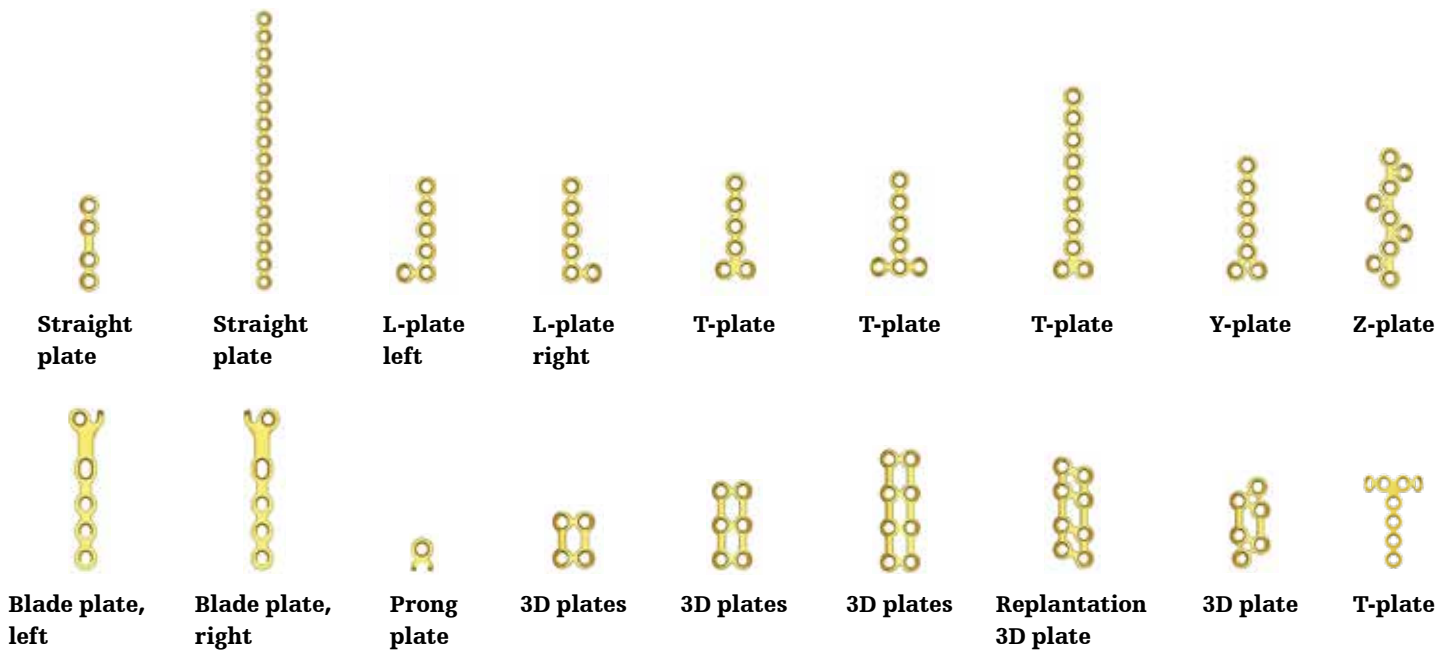

System overview

Implants: plate platform

2.3mm M VariAx Hand Locking Plates ●

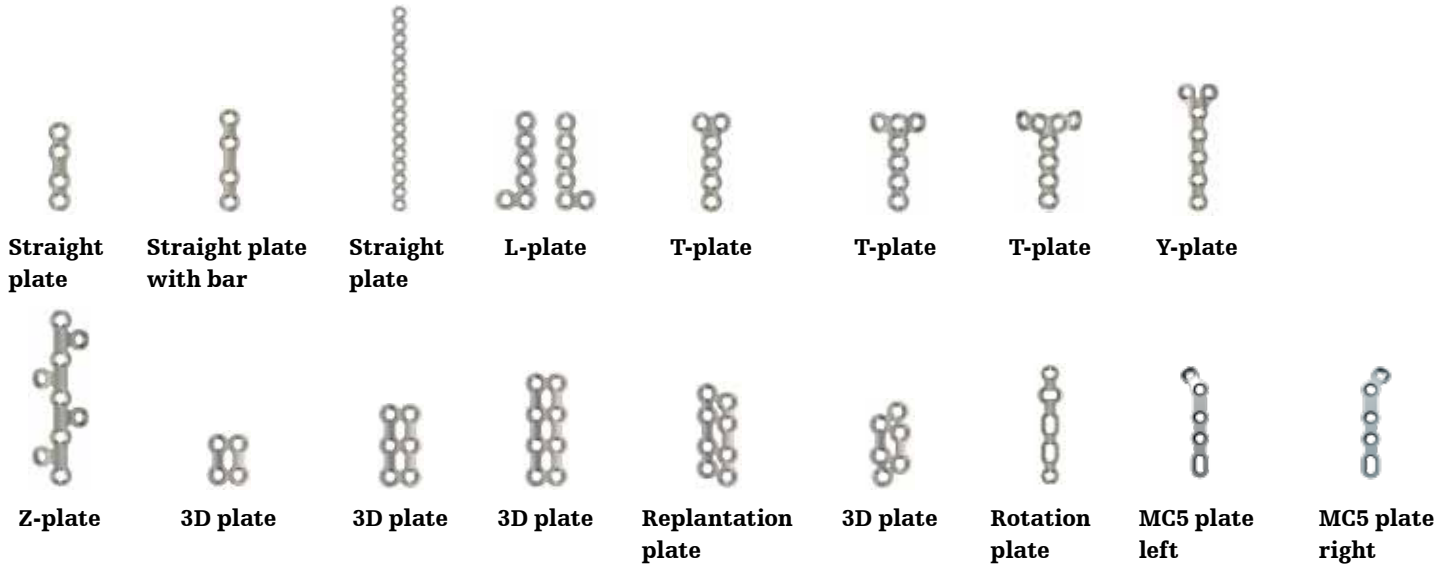

2.3mm M Profyle Hand Standard Plates ●

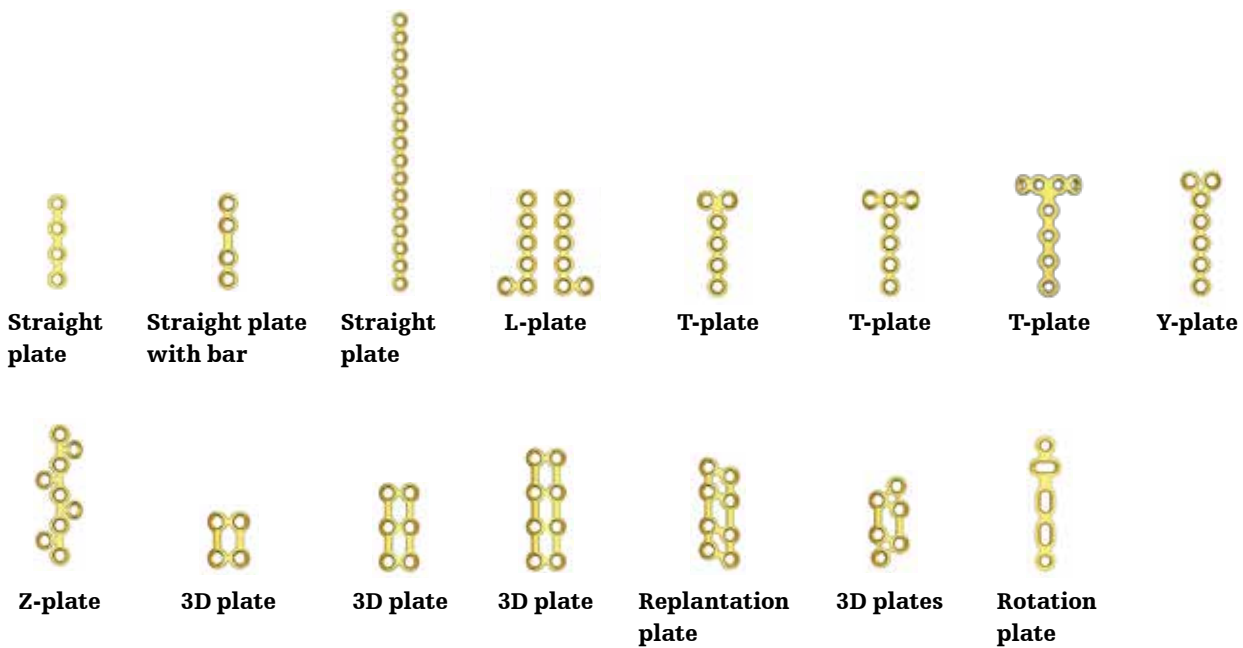

System overview

Implants: plate platform

2.3mm M Profile Hand Compression Plates ●

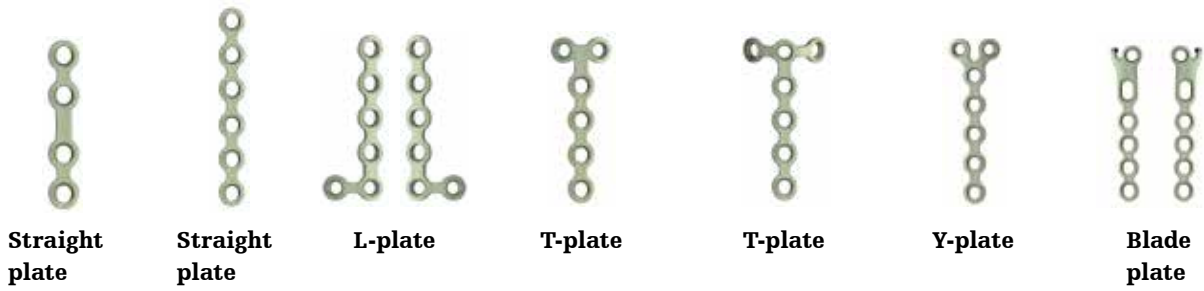

2.3mm L Profile Hand Compression Plates ●

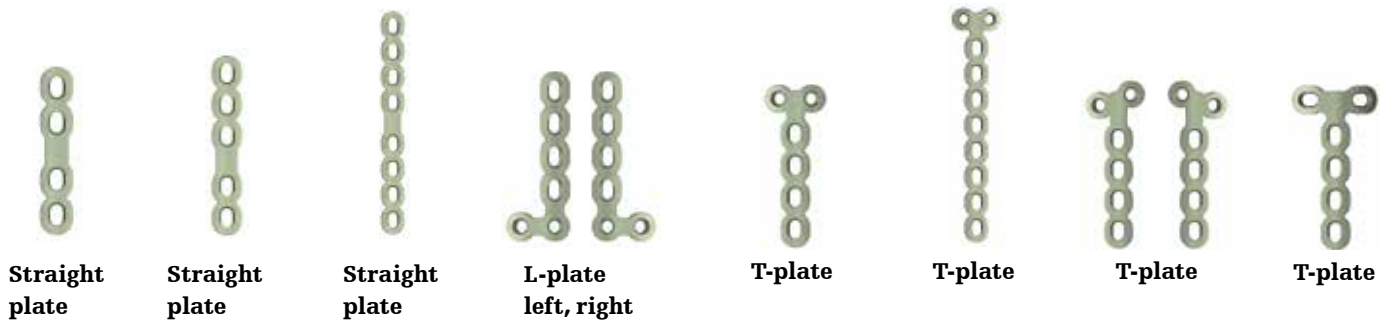

Operative technique

VariAx Locking Plates

⚠ CAUTION

The 1.7mm VariAx Locking Plates are not intended for use on the metacarpals

Step 1

Select an appropriate sized implant.

Step 2

Cut and/or contour the plate if necessary.

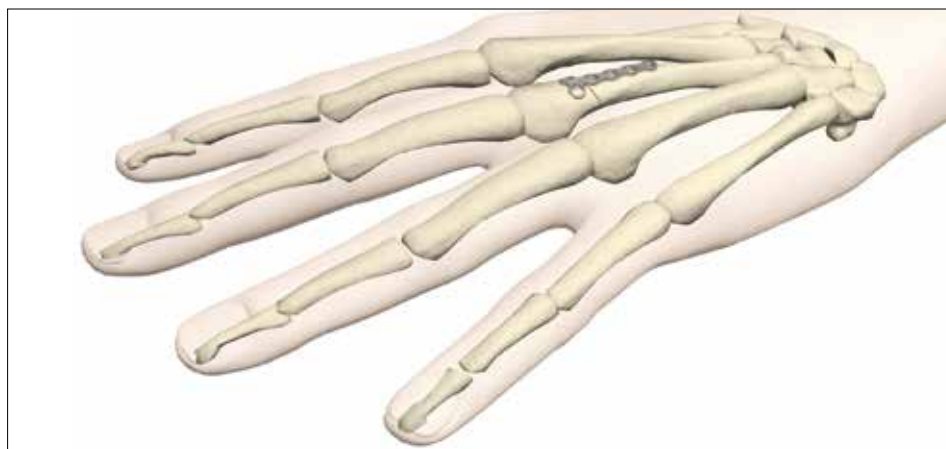

Step 3

Place the appropriate locking drill guide in the hole of the plate and aim the appropriate drill in the desired position. This drill guide will not allow for drilling past 10°.

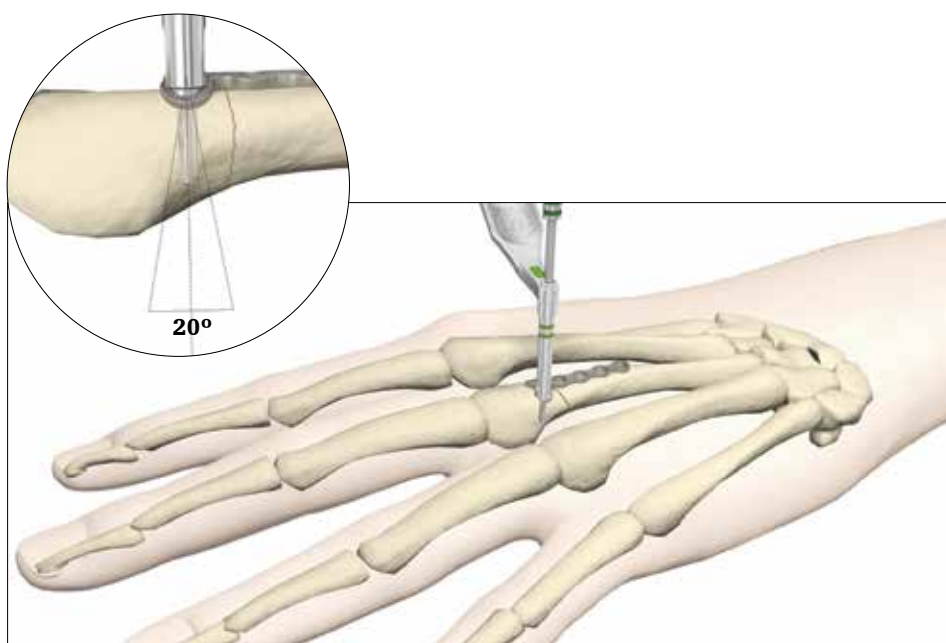

Operative technique

VariAx Locking Plates (continued)

Step 4

Measure for the length of the screw and then insert the proper locking screw.

Bone screws can also be used in any of the round holes if desired.

After measuring and selecting the appropriate screw length, always measure the length of the screw before implantation.

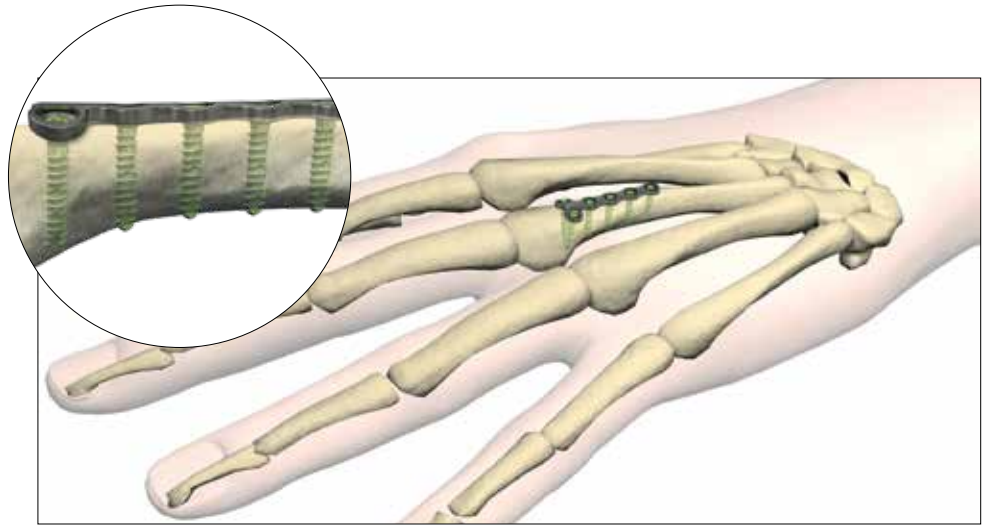

Operative technique

Metacarpal 5 plates

This anatomically shaped plate is available in left and right versions. The oblong holes allow for proper positioning of the plate in relation to the joint.

Step 1

Select the appropriate implant.



Step 2

Apply the plate laterally on the 5th Metacarpal.

To avoid distal placement, the plate should be positioned proximal to the MP Joint and the Collateral Ligament. The second most distal hole can be positioned over or proximal to the fracture. With the 10° polyaxial locking angulation, it is still possible to target the distal fragments with a locking screw.

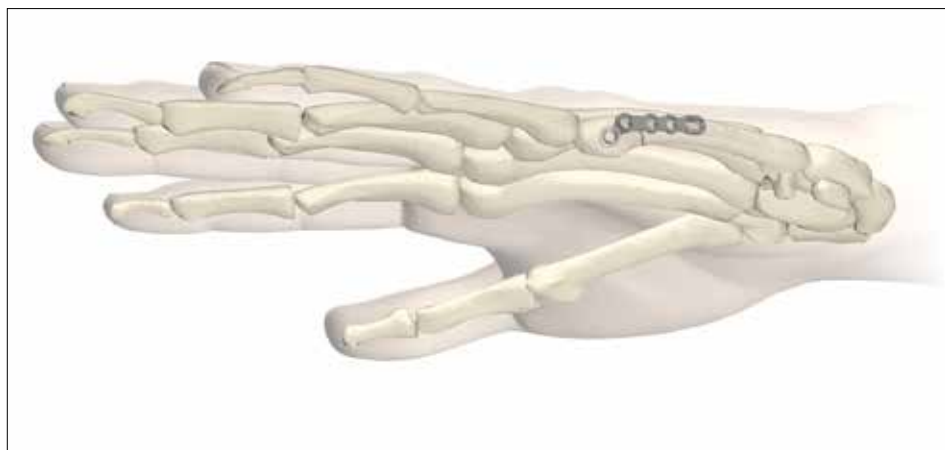

Step 3

Place the 2.3mm locking drill guide (Ref 62-51723) in the gliding hole and drill bi-cortically using the 1.9mm drill.

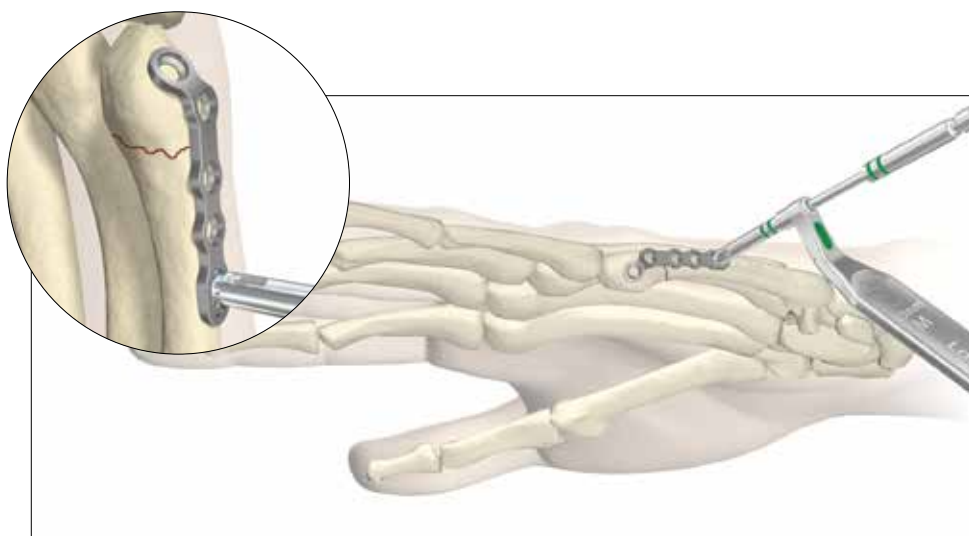

Operative technique

Metacarpal 5 plates (continued)

Step 4

Measure for the length of the screw.

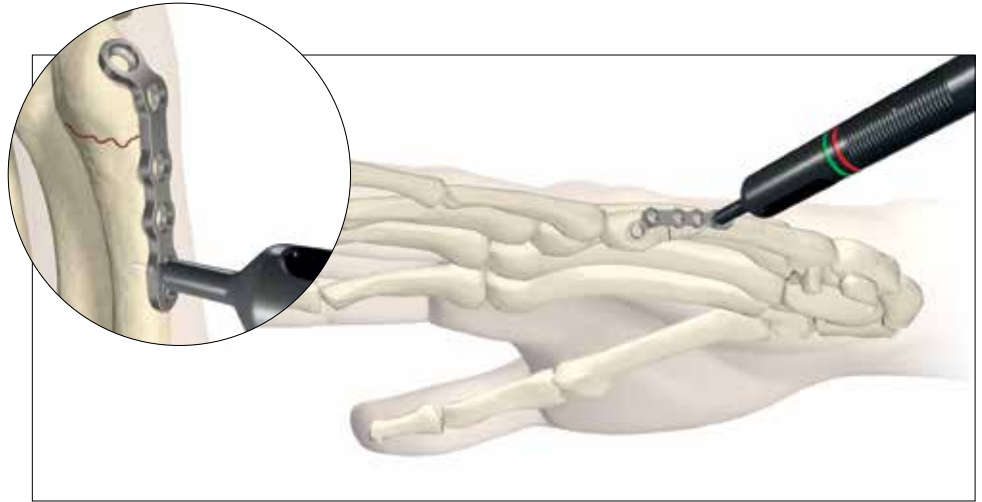

Step 5

Insert the proper length 2.3mm bone screw. Do not fully tighten the bone screw. Adjust the plate on the lengthwise axis. Once the plate is in proper position, final tightening of the bone screw is required.

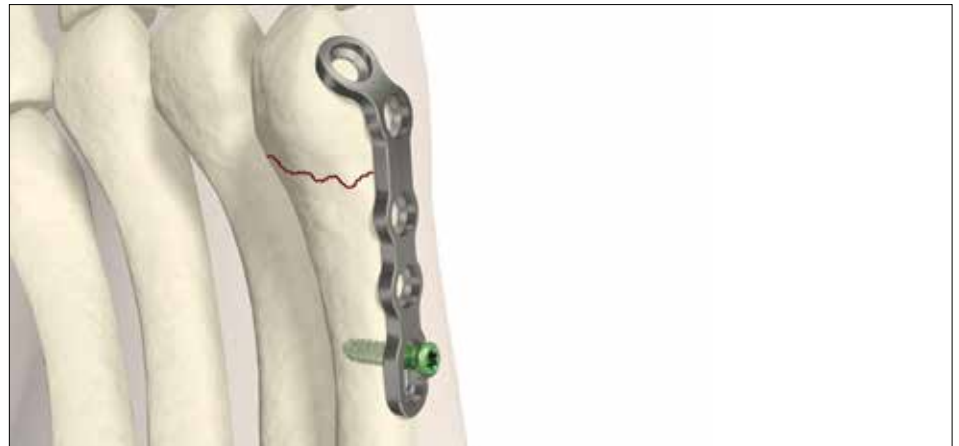

Step 6

Drill the remaining holes using the 2.3mm locking drill guide and the 1.9mm drill. Locking plates accept locking and non-locking screws.

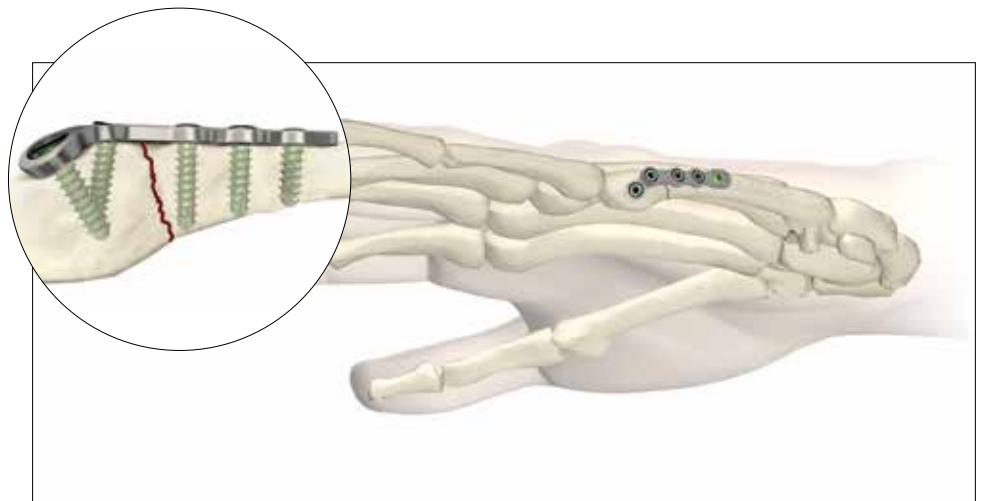

Operative technique

Rotation plates

The rotation plate is available as a locking plate or non-locking plate for use with 2.3mm or 1.7mm screws.

Step 1

Select an appropriate sized implant.



Step 2

Two screws are placed into the lengthwise gliding holes, but are not fully tightened. The screw in the lengthwise gliding holes should be placed proximally or distally to adjust the deviation in the lengthwise direction.

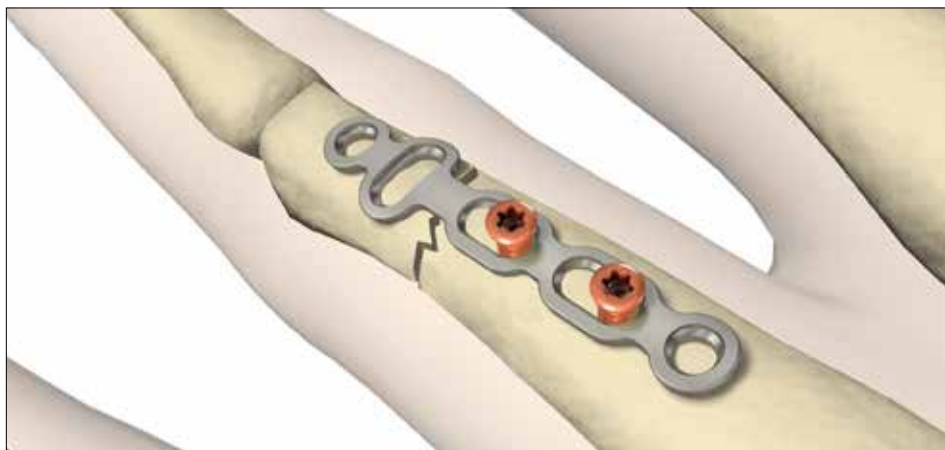

NOTICE

During bone screw insertion in an oblong hole, the surgeon should not angulate screws and should rely on tactile feedback to prevent excessive torque which may result in screw pull through. Proper observation of bone quality, screw size, and instrumentation can help determine the appropriate insertion torque during insertion and final tightening of the screw in the plate. When the screw is fully seated during final tightening, an increase of resistance indicates sufficient screw fixation.

Operative technique

Rotation plates (continued)

Step 3

The next screw is placed into the horizontal gliding hole and is not fully tightened.

The screw in the horizontal gliding hole should be positioned radial or ulnar depending on the rotational failure of the fracture.

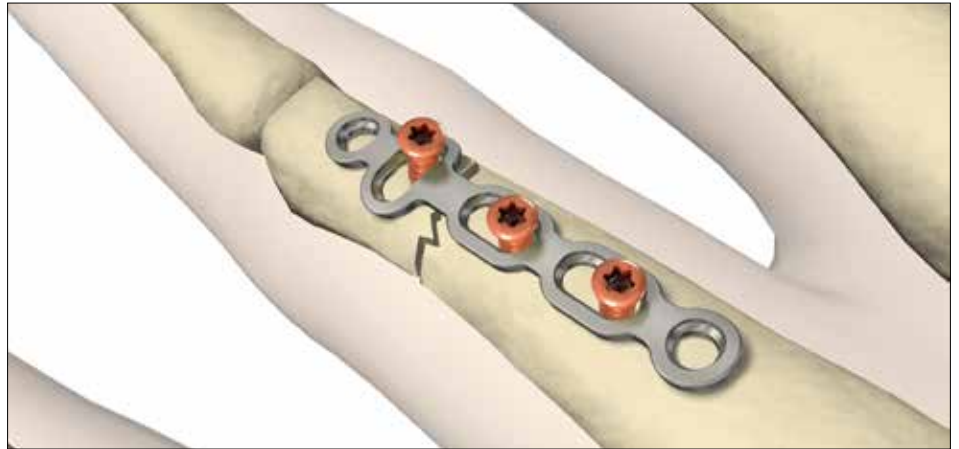

Step 4

First adjust on the lengthwise axis by reducing the fracture.

⚠ CAUTION

Depending on the fracture it may be necessary to reduce the horizontal axis first.

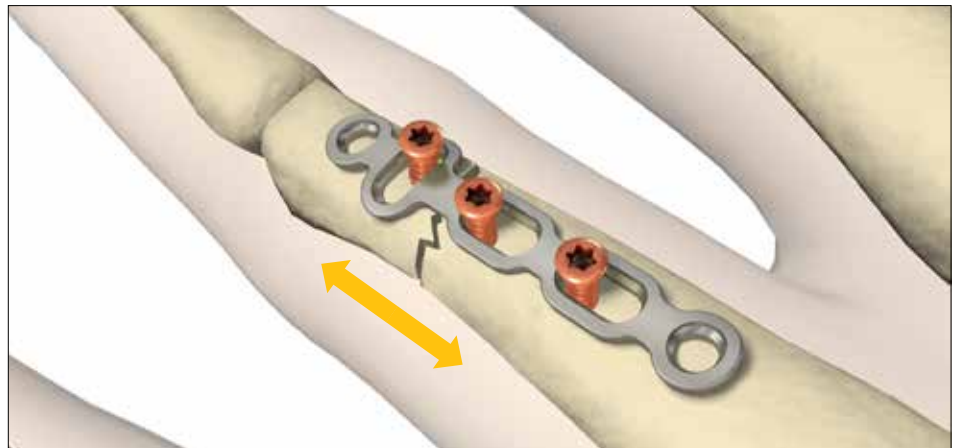

Step 5

Once the fracture is reduced, the screws in the lengthwise gliding holes can be tightened.

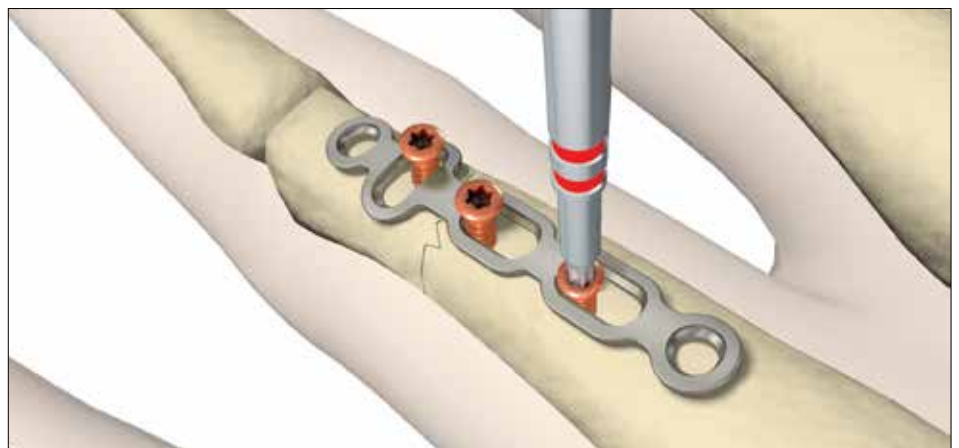

Operative technique

Rotation plates (continued)

Step 6

Now adjust the rotational deviation. Once the horizontal axis is aligned, the screw can be tightened.

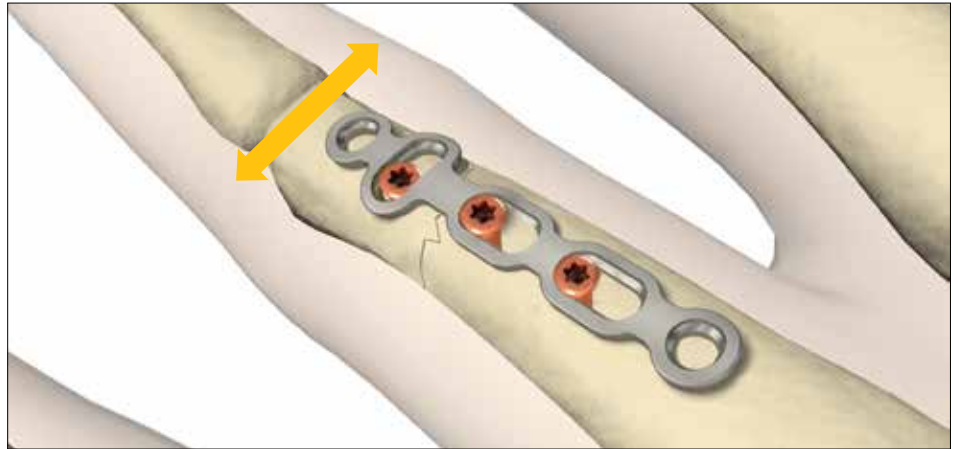

Step 7

After reduction, all other screws will be placed in the remaining holes to fixate the plate.

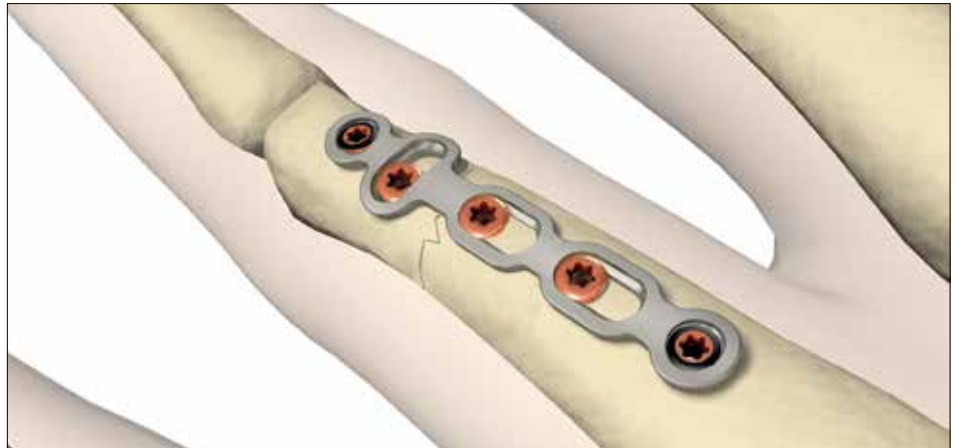

Operative technique

Profyle Hand Standard Plate

Step 1

Select an appropriate sized implant.

Step 2

Cut and/or contour the plate, if necessary.

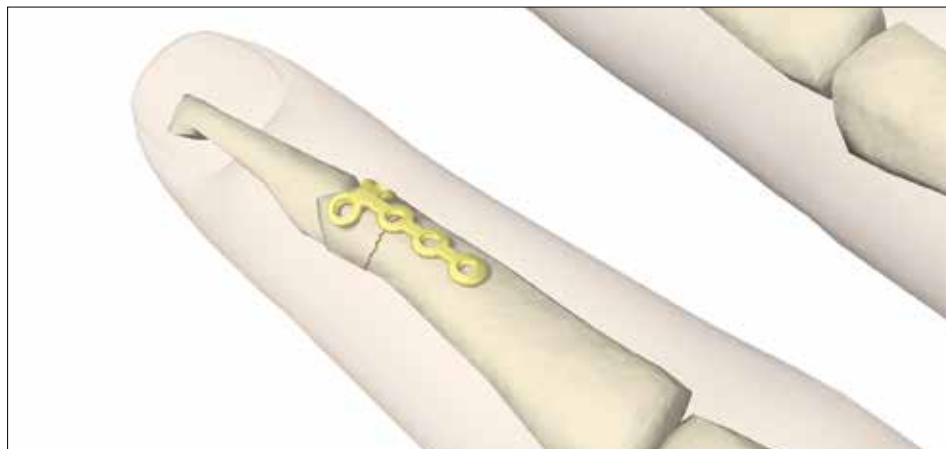

Step 3

Place the appropriate standard drill guide in the hole of the plate and aim the drill in the desired position.

Step 4

Measure for screw length after drilling.

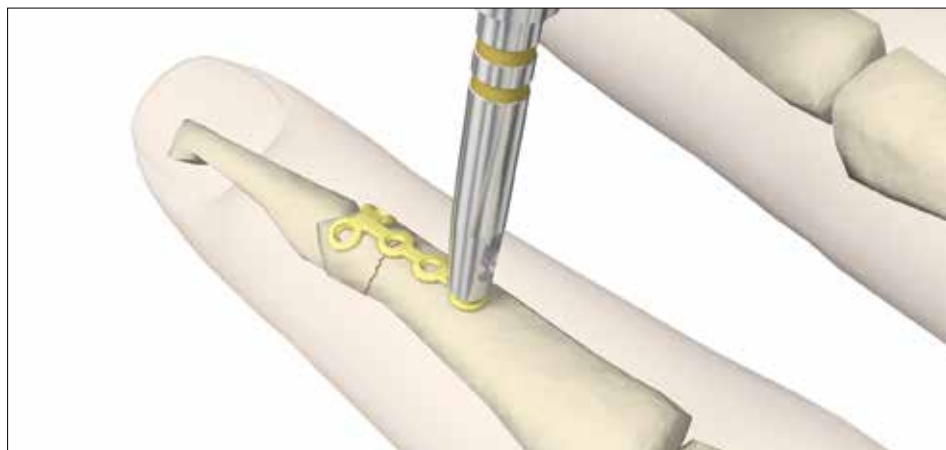

Operative technique

Profyle Hand Standard Plate (continued)

Step 5

The first bone screw should be fully inserted.

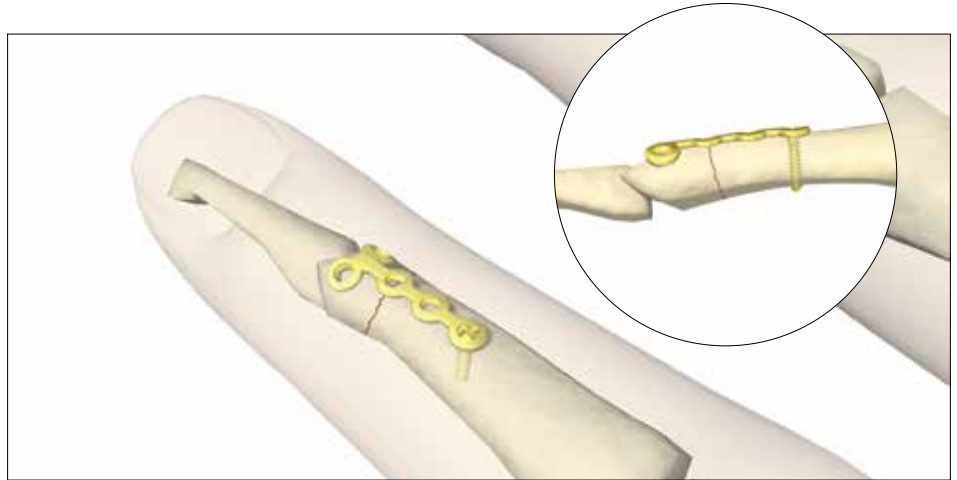

Step 6

Continue drilling with the appropriate standard drill guide for the remaining holes and insert remaining screws.

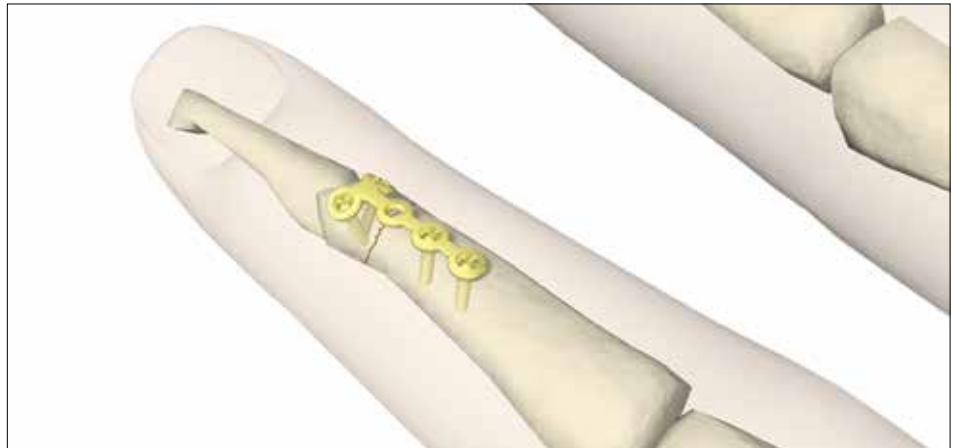

Operative technique

Profyle Compression Plates

NOTICE

When deciding which implant to choose, you should take into account the amount of compression needed.

- M compression plates achieve 0.5mm of compression.
- L compression plates achieve 1.5mm of compression.

Step 1

Select an appropriate sized implant.

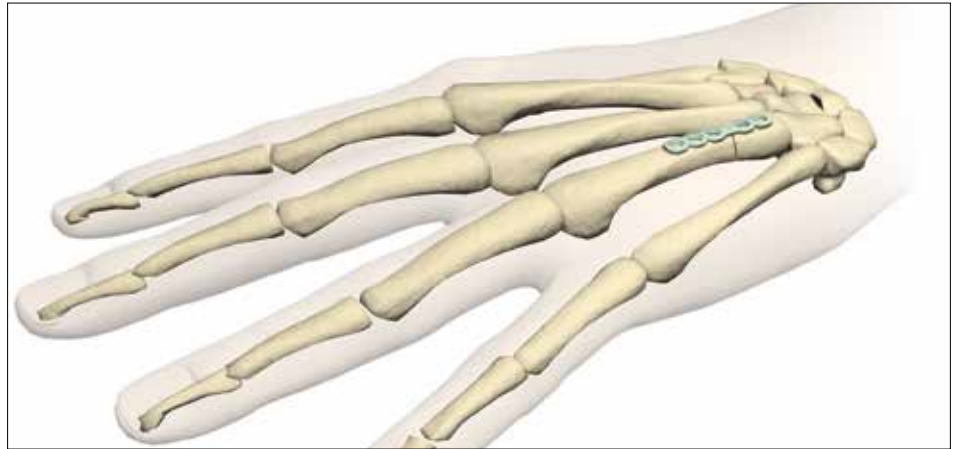

Step 2

To achieve stabilization, first drill in a neutral position using the 2.3mm standard drill guide in the hole closest to the fracture in the proximal fragment.

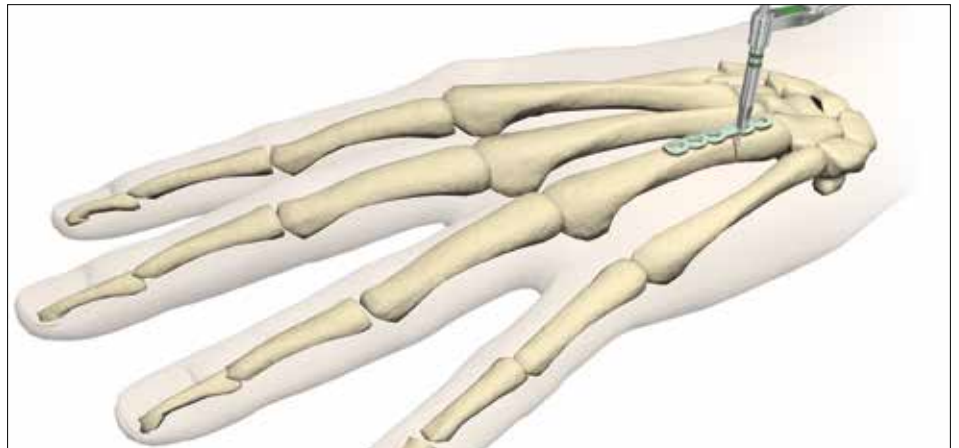

Step 3

Measure the length of the screw and fully insert the 2.3mm bone screw.

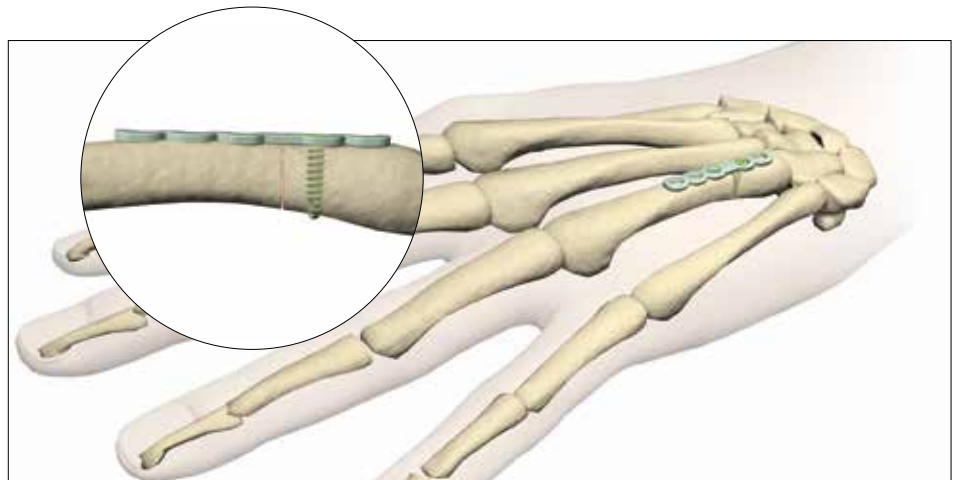

Operative technique

Profyle Compression Plates (continued)

Step 4

Apply the appropriate compression drill guide in the hole closest to the fracture on the opposite side of stabilizing screw.

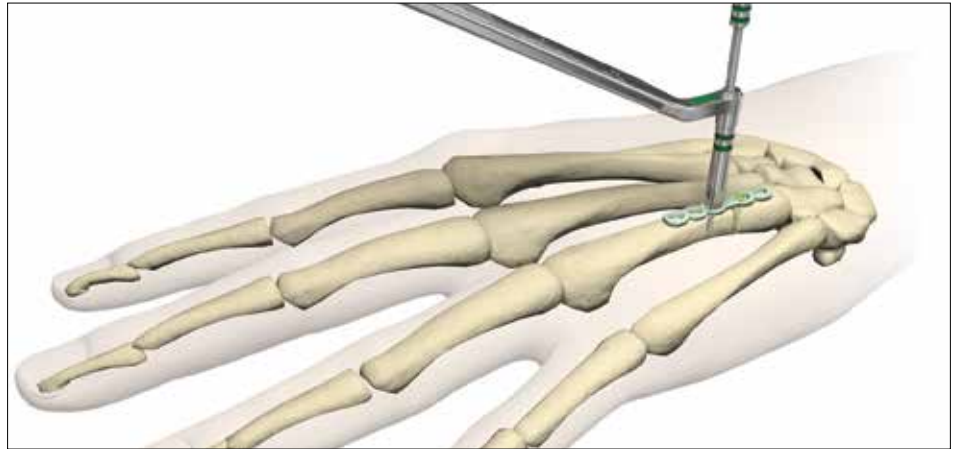

Step 5

As the screw is tightened, compression can be achieved.

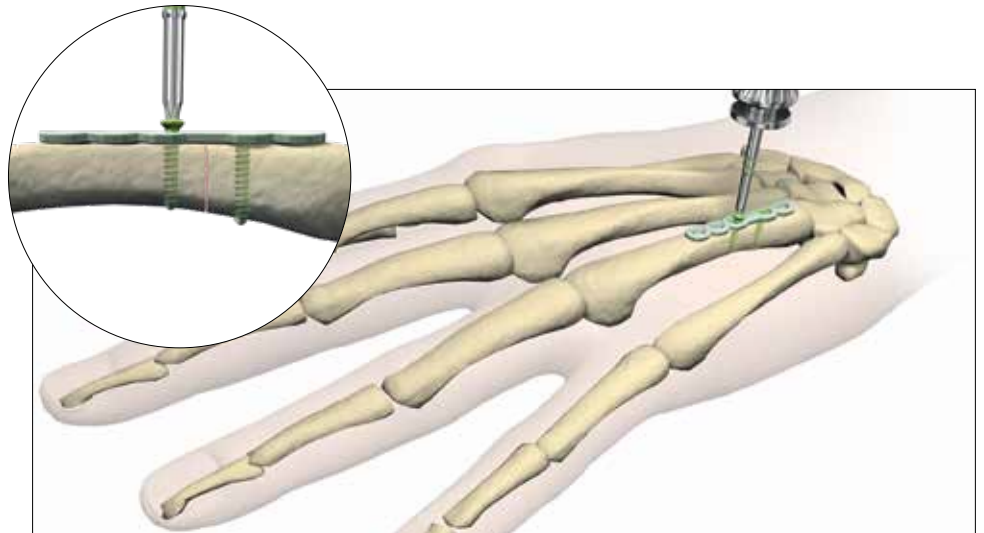

Operative technique

Lag Screws

Step 6

Continue drilling with the appropriate standard drill guide for the remaining holes and insert remaining screws.

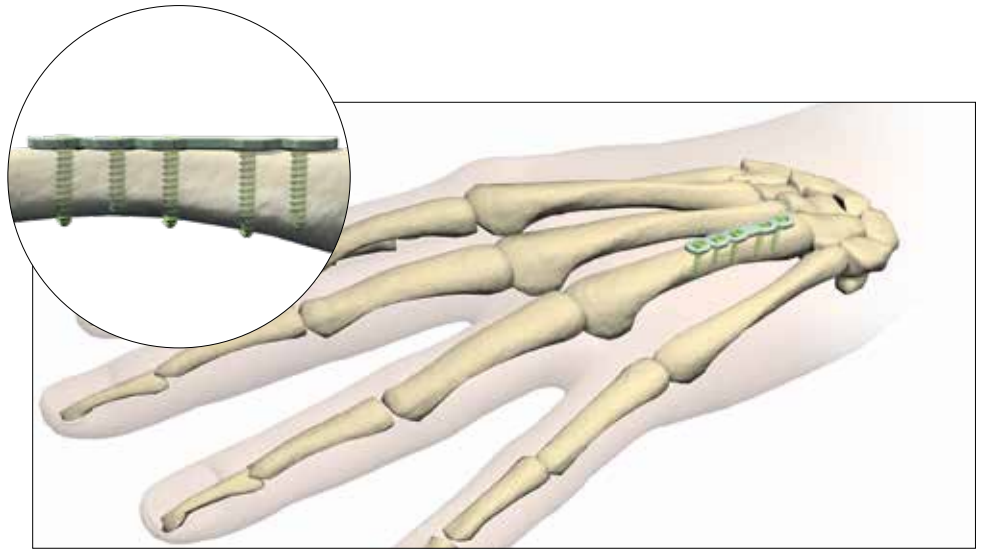

Operative technique

Lag Screws

Step 1

Create gliding hole by drilling the near cortex.

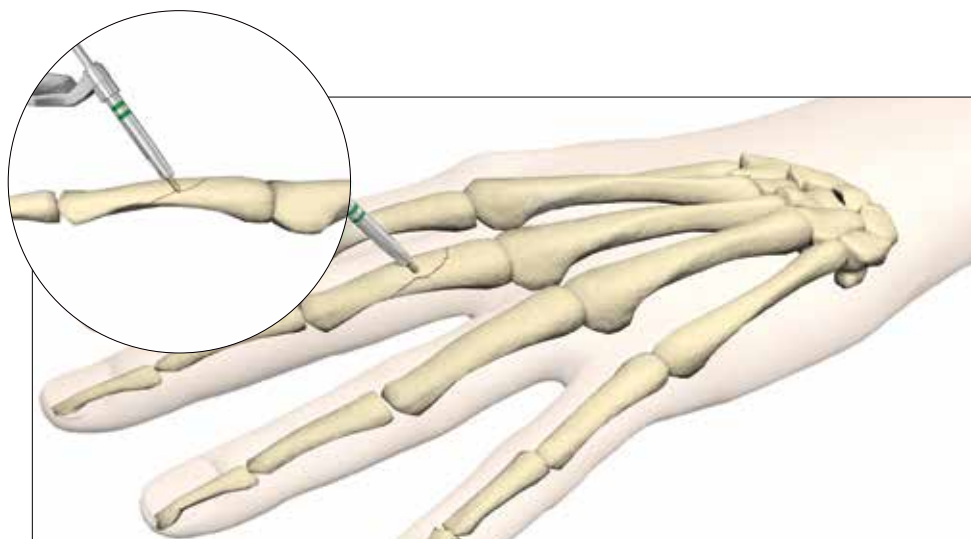

Step 2

Drill through the gliding hole to the far cortex.

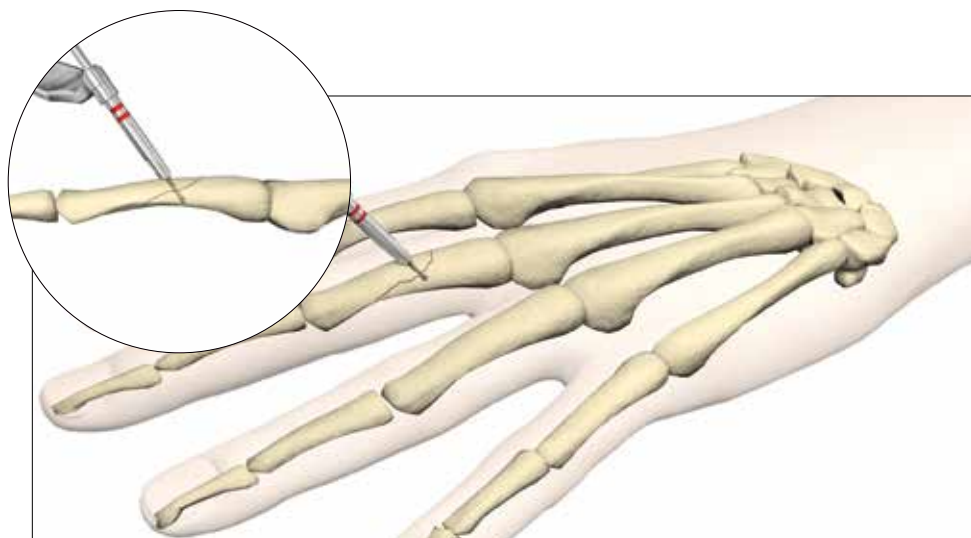

Step 3

Countersink or apply washer. Measure the length of the screw and fully insert the correct bone screw

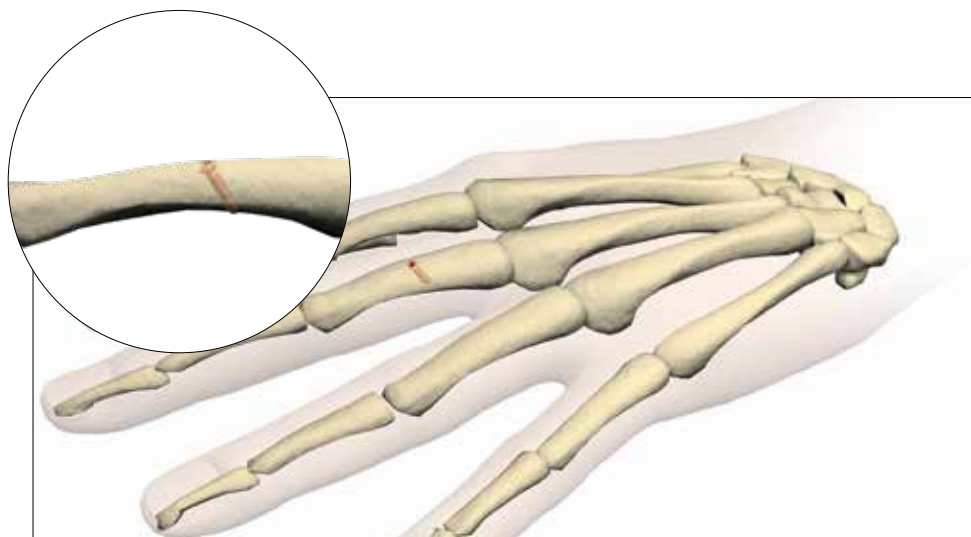

Operative technique

Lag screw target bow

Step 1

Incision and dissection of the soft tissue is followed by fracture reduction using the appropriate target bow. Tightening of the knurled knob holds the bone fragment.

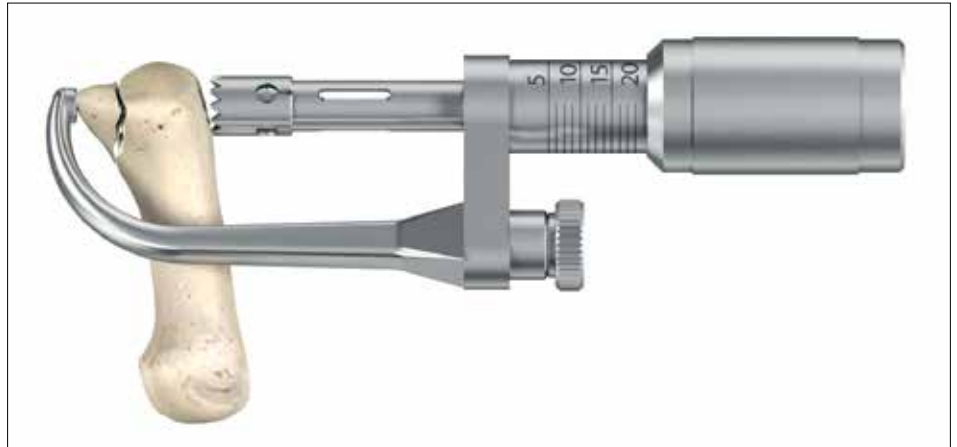

Step 2

Insert the drill guide.

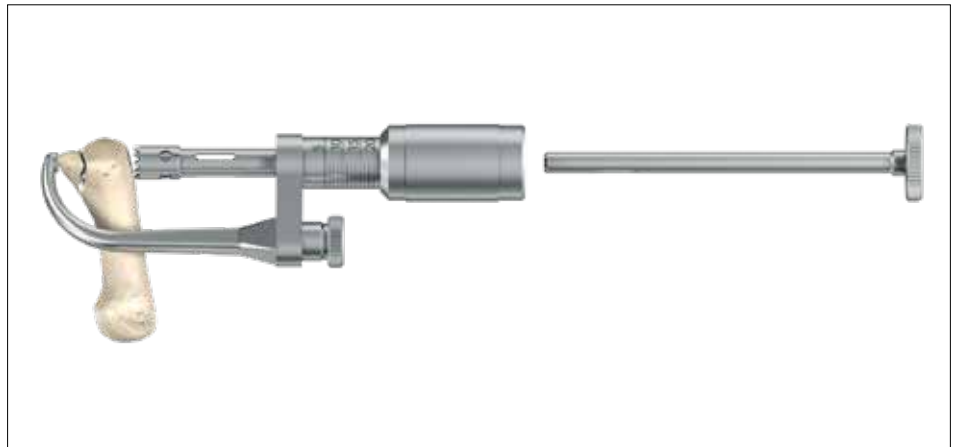

Step 3

Drill pilot hole through both cortices.

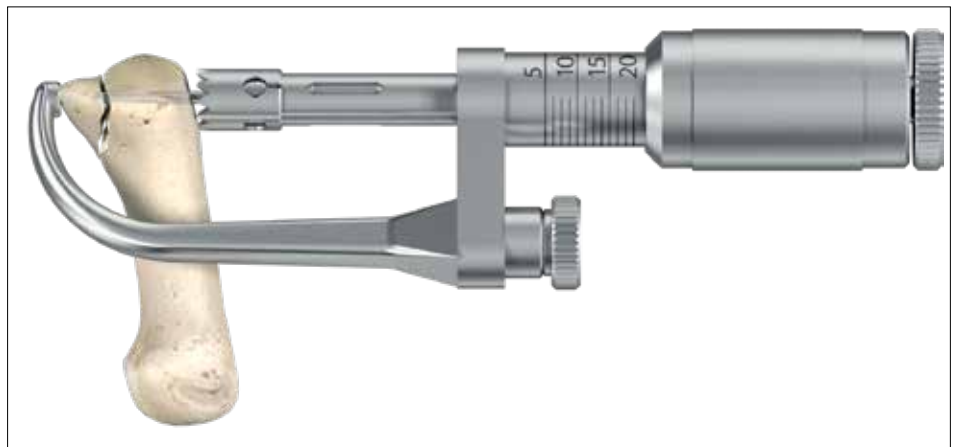

Operative technique

Lag screw target bow

Step 4

Overdrill the first cortex for gliding hole.

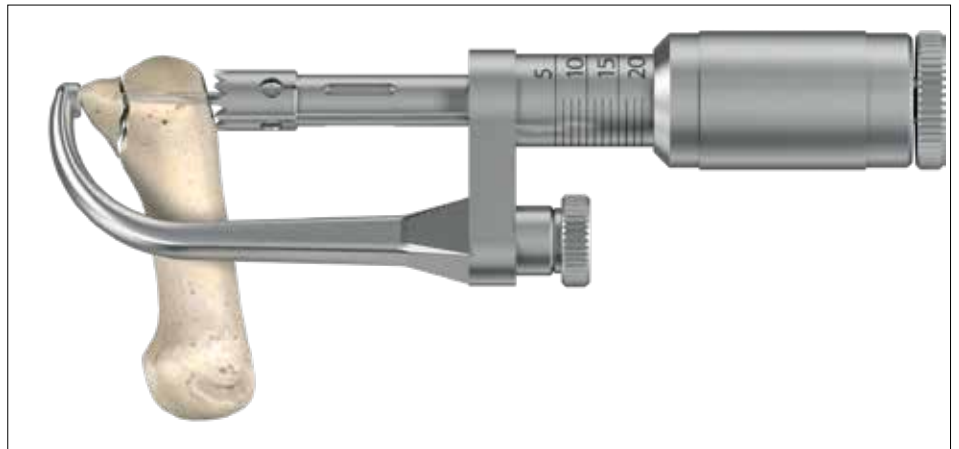

Step 5

Remove the drill guide and measure the screw length.

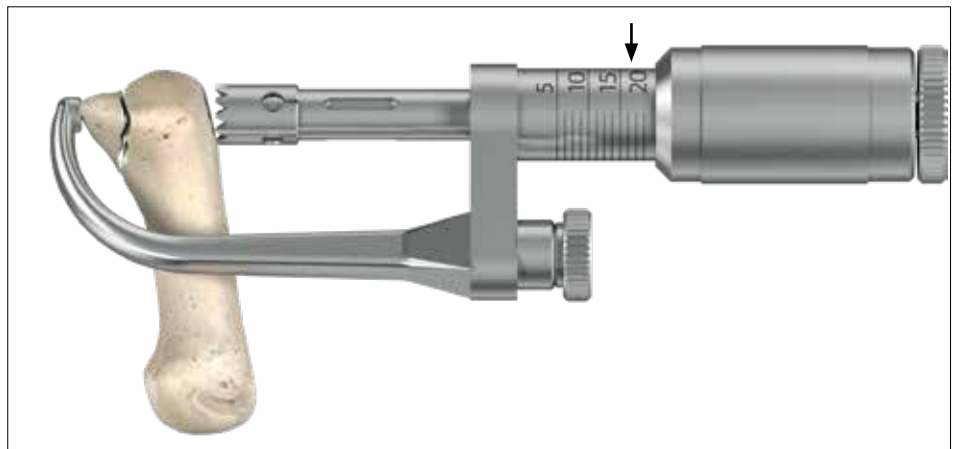

Step 6

Insert the screw with the applicable screwdriver blade. If necessary, use the corresponding washer.

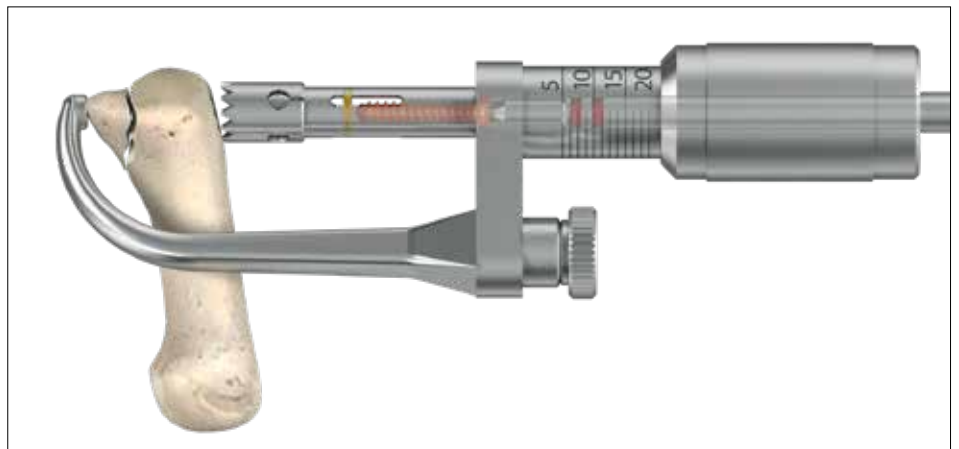

Operative technique

Lag screw target bow

Step 7

Tighten the screw and repeat the procedure for additional fixation.

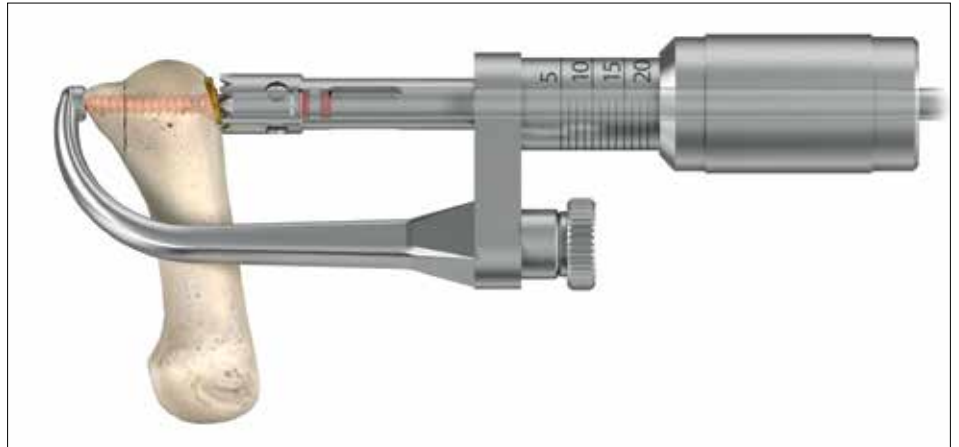

Step 8

Final screw placement.



Notes

Notes

Notes

Trauma & Extremities

This document is intended solely for the use of healthcare professionals. A surgeon must always rely on his or her own professional clinical judgment when deciding whether to use a particular product when treating a particular patient. Stryker does not dispense medical advice and recommends that surgeons be trained in the use of any particular product before using it in surgery.

The information presented is intended to demonstrate a Stryker product. A surgeon must always refer to the package insert, product label and/or instructions for use, including the instructions for cleaning and sterilization (if applicable), before using any Stryker product. Products may not be available in all markets because product availability is subject to the regulatory and/or medical practices in individual markets. Please contact your Stryker representative if you have questions about the availability of Stryker products in your area.

Stryker Corporation or its affiliates own, use, or have applied for the following trademarks or service marks: Profyle, Stryker, VariAx.

All other trademarks are trademarks of their respective owners or holders.

The product listed above are CE marked.

Content ID: VAX-ST-59_Rev 1, 11-2018

Copyright © 2018 Stryker



Manufacturer:

Stryker GmbH
Bohnackerweg 1
2545 Selzach
Switzerland
stryker.com